



TRAEGER
WOOD FIRED GRILLS

Wood Fired Grills – Century 22/34
ITM. / ART. 992154

USE & CARE INSTRUCTIONS

A MAJOR CAUSE OF FIRES IS FAILURE TO MAINTAIN REQUIRED CLEARANCES (AIR SPACES) TO COMBUSTIBLE MATERIALS. IT IS OF UTMOST IMPORTANCE THAT THIS PRODUCT BE INSTALLED ONLY IN ACCORDANCE WITH THESE INSTRUCTIONS.

IMPORTANT, RETAIN FOR FUTURE REFERENCE: READ CAREFULLY



IMPORTANT SAFETY

IMPORTANT: READ CAREFULLY AND RETAIN FOR FUTURE REFERENCE.

If you are assembling this unit for someone else, provide this manual for the owner to read and save for future reference.

READ ALL INSTRUCTIONS BEFORE INSTALLING AND USING THE APPLIANCE

Please read this entire manual before installation and use of this pellet-burning appliance. Failure to follow these instructions could result in property damage, bodily injury, or even death. Contact local building or fire officials about restrictions and installation inspection requirements in your area.

Cooking with a hardwood fire will bring years of enjoyment to you, your family, and those lucky friends you will be cooking for. Your new Traeger Grill is especially designed to make cooking easier, while giving you optimal performance with the most savory-flavored food.

As with all grills and cooking appliances, any time you burn a material (whether it be wood, gas, or charcoal), organic gases are formed during the cooking process. One gas that can be particularly harmful in concentrated quantities is carbon monoxide. In an outdoor, open-air environment, carbon monoxide should naturally dissipate and not harm you.

WARNING! Follow these guidelines to prevent this colorless, odorless gas from poisoning you, your family, or others:

- Know the symptoms of carbon monoxide poisoning: headache, dizziness, weakness, nausea, vomiting, sleepiness, and confusion. Carbon monoxide reduces the blood's ability to carry oxygen. Low blood oxygen levels can result in loss of consciousness and death.
- See a doctor if you or others develop cold- or flu-like symptoms while cooking or in the vicinity of this appliance. Carbon monoxide poisoning, which can easily be mistaken for a cold or flu, is often detected too late.
- Alcohol consumption and drug use increase the effects of carbon monoxide poisoning.
- Carbon monoxide is especially toxic to mother and child during pregnancy, infants, the elderly, smokers, and people with blood or circulatory system problems, such as anemia or heart disease.
- Only use your Traeger outside on a noncombustible floor and away from combustible materials.
- Never use gasoline, gasoline-type lantern fuel, kerosene, charcoal lighter fluid, or flammable liquids to start or "freshen up" a fire in this appliance. Keep all such liquids well away from this appliance when in use.

DANGER!

- Plug into an appropriate 3-prong outlet.
- An electrical supply with GFCI protection is required. To protect against shock hazard, locate a grounded 3-prong receptacle in reach of the 1.8 m (6') power cord. When installing the receptacle, follow the National Electrical Code and local codes and ordinances.

DANGER!

- Hazardous voltage is present which can shock, burn, or cause death. Disconnect the power cord before servicing the grill unless otherwise noted in the Use & Care Instructions.
- Never use or store flammable liquids near the grill.
- Never use gasoline or lighter fluid to manually light your grill. Use **ONLY** alcohol gel for this procedure **AND** according to the instructions in the Use & Care Instructions.

WARNING!

Many parts of the grill will become very hot during operation. Care must be taken to avoid burns, both during operation and afterwards, while the grill is still hot.

- **Never** leave the grill unattended when young children are present.
- **Never** move the grill when it is operating.
- Let the grill cool thoroughly before moving or attempting to transport.

WARNING!

- When operating this grill, maintain a **MINIMUM** distance of 30.48 cm / 12 in / 12 po from the grill to combustibles.
- When operating this grill under overhead combustibles, a **MINIMUM** of 101.6 cm / 40 in / 40 po is required.

WARNING!

- Assemble and operate this grill **ONLY** per the instructions in the Assembly Guide and the Use & Care Instructions.
- This grill is intended for **OUTDOOR USE ONLY**.
- Never use heating fuel pellets in the grill, due to potential hazardous contaminants and additives that may be present.
- For best results and flavor, use genuine Traeger wood pellets.

CAUTION!

- Always store wood pellets in a dry location, away from heat-producing appliances and other fuel containers.
- Keep the grill clean – See the cleaning instructions in this Use & Care Instructions.
- Do not use accessories not specified for use with this grill.

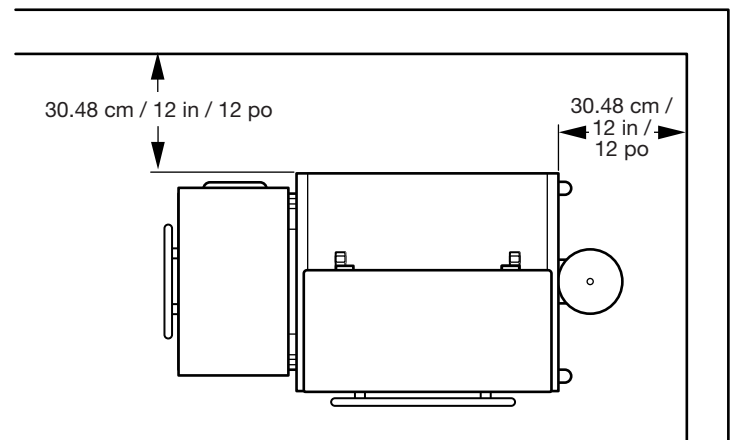
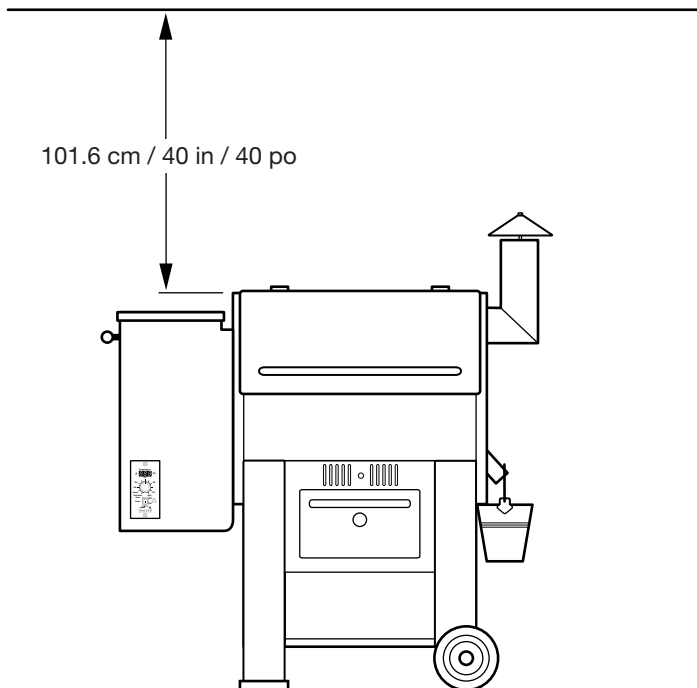

SAVE THESE INSTRUCTIONS



WE'VE GOT YOU COVERED

traegergrills.com/shop

RUBS



PELLETS



SAUCES





TABLE OF CONTENTS

2	Important Safety
6	Adding Flavor to Your Fire
8	Grill Components
10	Initial Firing Instructions
13	Subsequent Start-Up
14	Using the Traeger® Warming Drawer
15	Operating Tips
17	Hopper Clean-out
18	Maintaining Your Grill
20	Reigniting Your Grill
22	Frequently Asked Questions
25	Wiring Diagram
26	Service and Support
27	Warranty



**Register your grill
online for a FREE
Traeger ebook**

Go online at
traegergrills.com/register

ADDING FLAVOR TO YOUR FIRE

PELLETS

































Traeger makes nine different pellet types so you can serve up a feast of different flavors. Clean-burning and environmentally safe, our natural wood pellets are made from U.S.-grown timber, ignite fast with low ash residue, and are crafted in one of our three Traeger-owned mills. By making our own pellets, we can guarantee that from mill to grill, there's nothing but 100% pure virgin hardwood flavoring your food.

HARDWOOD

PELLET GUIDE



GOOD FOR ANYTHING. GREAT FOR:

ALDER						
APPLE						
CHERRY						
HICKORY						
MAPLE						
MESQUITE						
OAK						
PECAN						

**OUR HARDWOOD PELLETS COME IN
8 GREAT VARIETIES!**

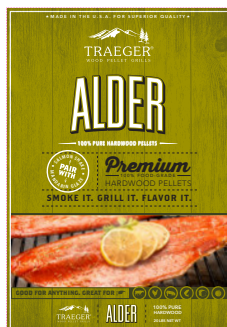

ALDER PEL307

Versatile because of its mild flavor and aroma, alder gives off ample smoke without overwhelming even the most delicate flavors.

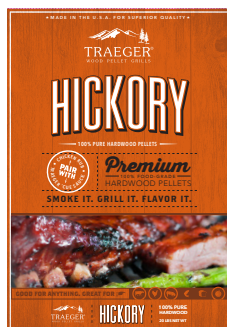

HICKORY PEL319

The most widely used pellets in barbecue, hickory pellets release a strong flavor and complement most meats.



OAK PEL310

Stronger than cherry or apple and lighter than hickory, oak is great to use with fish and beef.



APPLE PEL318

Most often used with poultry and pork, apple pellets offer a lightly sweet smoke that helps enhance mild-flavored meats.



CHERRY PEL309

A very flavorful pellet, cherry wood lends itself to applications where you want to add a hearty smoke flavor.



MAPLE PEL308

Mild, with a hint of sweetness, maple pellets are great on pork and especially veggies.



MESQUITE PEL305

A favorite of Texas BBQ, mesquite pellets infuse your meat with a robust smoke flavor.



PECAN PEL314

Deliciously nutty and even a little spicy, pecan pellets are great with veggies, beef, pork, poultry, or even baked goods.

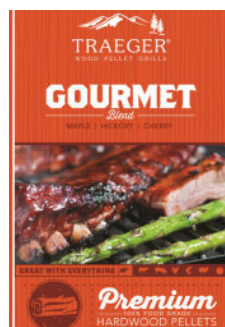

Gourmet Blend (Costco Exclusive 33 lb Bag) PEL316

A robust blended flavor of sweet maple complemented by notes of savory hickory and tart cherry.

GRILL COMPONENTS

GET TO KNOW YOUR GRILL

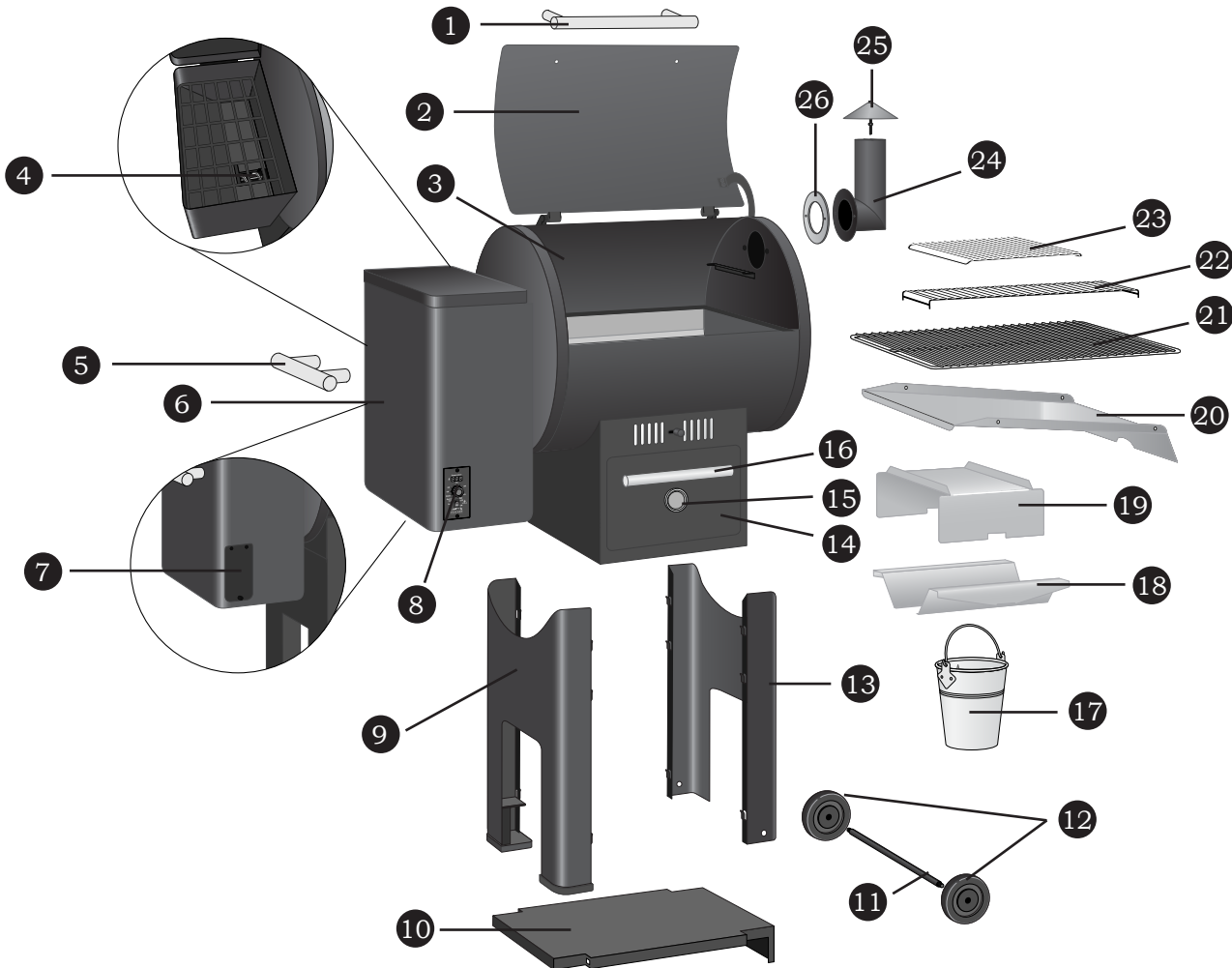

Part	Description
1	Grill Door Handle
2	Grill Door
3	Grill Barrel
4	Auger (Pellet Hopper Interior)
5	Side Lift Handle
6	Pellet Hopper
7	Pellet Hopper Clean-out Door
8	Digital Elite Controller
9	Stationary Leg
10	Bottom Shelf
11	Axle
12	Wheels
13	Wheeled Leg

Part	Description
14	Traeger® Warming Drawer
15	Warming Drawer Thermometer
16	Warming Drawer Handle
17	Grease Bucket
18	Lower Heat Baffle
19	Upper Heat Baffle
20	Grease Drain Pan
21	Porcelain-Coated Grill Grate
22	Extra Grill Rack
23	Warming Drawer Rack
24	Smokestack Flue Pipe
25	Chimney Cap
26	Flue Pipe Gasket

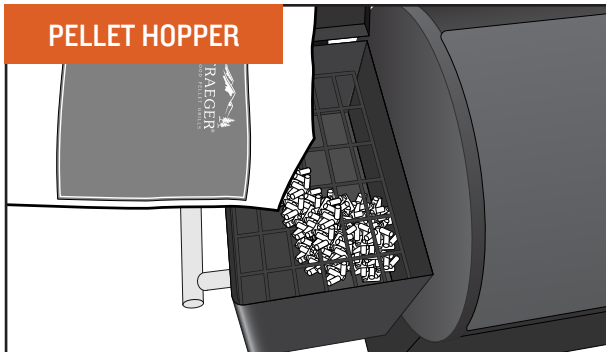

PELLET HOPPER

With a pellet hopper capacity of 10.89 kg / 24 lbs that's easy to change out, you have more flavor options than ever. Pair that with Traeger's Digital Elite Controller and delicious food is just a "click" away.

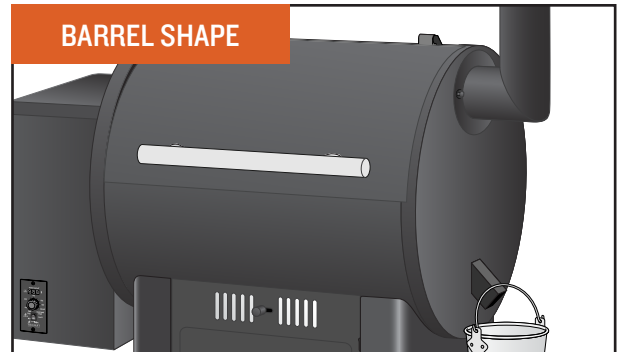

BARREL SHAPE

Traeger's signature barrel shape creates a vortex of convection. It circulates hot, smoky air around the cooking chamber, surrounding your food with heat and cooking it evenly on all sides.



GRILLING SPACE

With 0.37 m² / 572 in² of grilling space and 20,000 BTUs of wood-fired heat, your Traeger Grill has the real estate and cooking power for party-sized orders of T-bones or racks of ribs, as well as a convenient warming drawer for yummy rolls or sides.

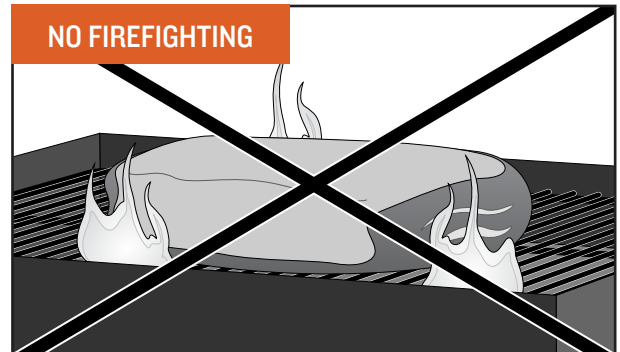

NO FIREFIGHTING

You don't ever have to worry about drippings flaring up* and causing those nasty fireballs that destroy your meal, because Traeger Grills are designed to cook by using indirect heat. All drippings are safely channeled outside of the cooking chamber into a bucket for easy disposal.

***With proper, recommended maintenance**

COMPLETE THESE STEPS TO GET TRAEGER'ING (REFER TO THE ASSEMBLY GUIDE)

1. Attach stationary and wheeled legs to grill frame assembly.
2. Attach wheels.
3. Insert bottom shelf between legs.
4. Flip grill over and attach side lift and grill door handles.
5. Attach the smokestack to the main grill body.
6. Assemble interior grill components by placing lower heat baffle, upper heat baffle, grease drain pan, racks.

7. Place rack in warming drawer.
8. Hang the grease bucket.

TOOLS SUPPLIED FOR ASSEMBLY

- (2) Open-end wrenches
- (1) Screwdriver

INITIAL FIRING INSTRUCTIONS

To be used on initial firing or any time the grill runs out of pellets.

In order to ensure proper operation of the grill, you must first allow the auger tube to be “charged” with pellets.



1

Remove the porcelain-coated grill grate, grease drain pan, and both upper and lower heat baffles from the inside of the grill.

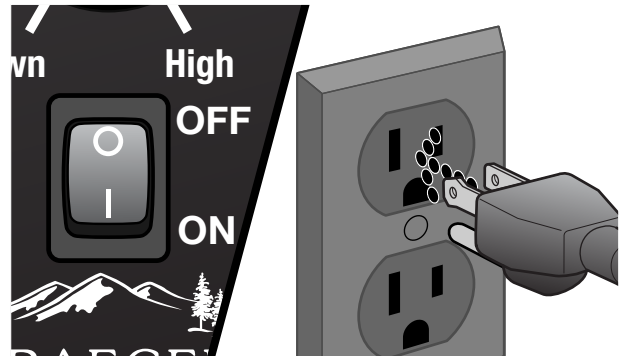

2

With the switch in the OFF (O) position, plug the power cord into an appropriate grounded electrical outlet.



3

Make sure there are no foreign objects in the auger. Turn the switch ON (I) and the temperature dial to SMOKE. Make sure the auger is turning (inside the pellet hopper).

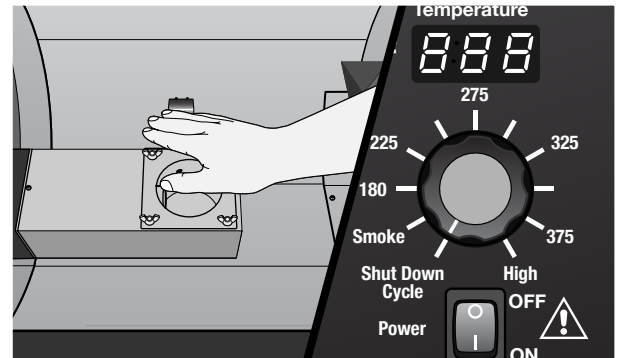

4

Check that there is air movement from the draft inducer fan by placing your fingers over the firepot. If the hot rod is getting hot, it will turn red. **CAUTION! Do not touch the hot rod.** Turn the temperature dial to SHUT DOWN CYCLE.

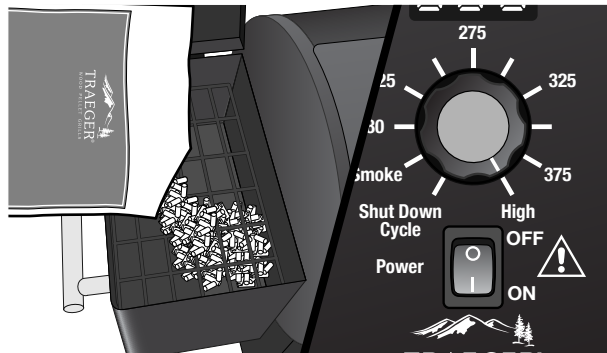

5 Fill the hopper with Traeger Hardwood Pellets and turn the temperature dial to HIGH.

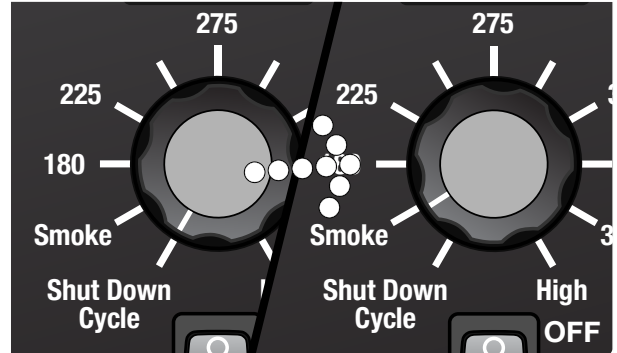

6 When the pellets begin to fall into the firepot, turn the temperature dial to SHUT DOWN CYCLE to reset the hot rod. Then with pellets still in the firepot, turn the temperature dial back to SMOKE.

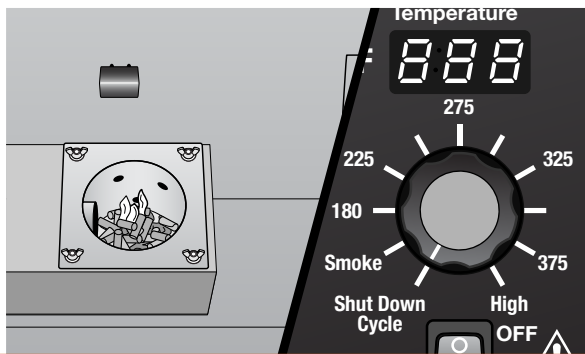

7 When flames start coming out of the firepot, turn the temperature dial to SHUT DOWN CYCLE and switch to OFF. Let the grill cool down.



8 Now you're ready to place the lower and upper heat baffles, grease drain pan, and porcelain-coated grill grates back into the grill.

Recommendation: For easy cleanup, line the grease drain pan with heavy-duty aluminum foil. Be sure the edges and ends of the foil are tight against the bottom of the grease drain pan. Replace foil after each cook to reduce the possibility of a grease fire. Please see page 18 for more details.

INITIAL FIRING INSTRUCTIONS (cont.)



9

With the door open, turn the switch ON (I) and the temperature dial to SMOKE. In about 2 minutes, the pellets will ignite and whitish-gray smoke will come out of the grill. After the pellets have ignited, close the door and turn the temperature dial to any cooking setting desired.



10

Before using your grill for the first time, it will need to be seasoned. Turn the temperature dial to HIGH and let run for 45 minutes with the door closed.

WARNING!

- **Start the grill on SMOKE setting with the door open.** Once the pellets are ignited, close the door and set the temperature dial to any desired cooking temperature.
- When operating this grill, maintain a minimum clearance of 30.48 cm / 12 in from grill to combustibles.
- For best results and flavor, always use genuine Traeger Hardwood Pellets. Never use heating fuel pellets in the grill.
- Clean the grease drain pan frequently to reduce the possibility of a grease fire. Please see page 18 for more details.

CONTROLLER SHUT DOWN CYCLE

The controller for this barbecue comes with an automatic shut down cycle. When finished cooking on your barbecue, set the temperature dial to the SHUT DOWN CYCLE position. This will leave the draft induction fan running for 10 minutes to burn any excess pellets in the firepot. After 10 minutes, the control will power off and the fan will stop running.

DANGER! The main power switch will shut off power to the control, and the temperature dial switch will shut off power to the grill components only. When servicing the controller or any other parts, ensure that the power supply is disconnected to avoid an electrical shock hazard.

SUBSEQUENT START-UP



- 1 With the door open, turn the switch ON (I) and the temperature dial to SMOKE. In about 2 minutes, the pellets will ignite and whitish-gray smoke will come out of the grill. After the pellets have ignited, close the door and turn the temperature dial to any cooking setting desired.

- 2 Allow the grill to preheat for about 10 minutes with the door closed before placing food in the grill.

NOTE: If the grill hasn't achieved the set temperature after a full 10-minute preheat, turn the dial to SHUT DOWN CYCLE, then back to the originally selected temperature.

If this fails to achieve the selected temperature, please see Operating Tips for more information.

CONTROLLER SAFETY FEATURES

The controller comes equipped with two safety features that will help you keep the grill operating correctly.

LOW TEMPERATURE ALARM

If the grill stays below 51.67°C / 125°F as read by the RTD temperature sensor for a period of 10 minutes, the control will go into an alarm state and the display will read "LEr." This will turn off all power to the internal components of the grill. The display will stay in this state until you turn off the main power switch.

HIGH TEMPERATURE ALARM

If the grill reaches an internal temperature reading of 287.78°C / 550°F as read by the RTD temperature sensor, the control will go into alarm state and the display will read "HEr." This will turn off all power to the internal components of the grill. The display will stay in this state until you turn off the main power switch.

Whenever either of these alarm conditions occurs, you should check to see what caused this condition and fix the problem. Call Traeger's VIP-365 Customer Service (see page 26) if you need help.

USING THE TRAEGER WARMING DRAWER

The lower cabinet of your Traeger Grill is designed to act as a warming drawer that can be used to gently heat foods like bread or rolls, or keep already-cooked food items warm until the rest of your meal is done.

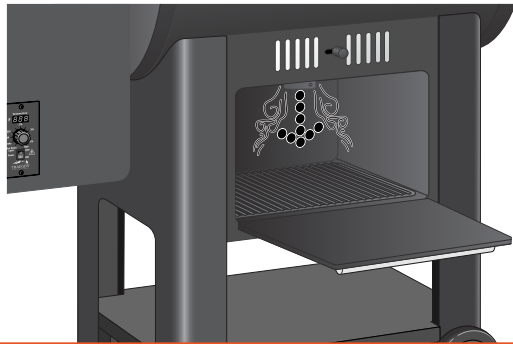

The drawer is warmed by two sources: ambient heat from the drum during cooking, and heated air redirected through the circular vent on the drawer's roof.

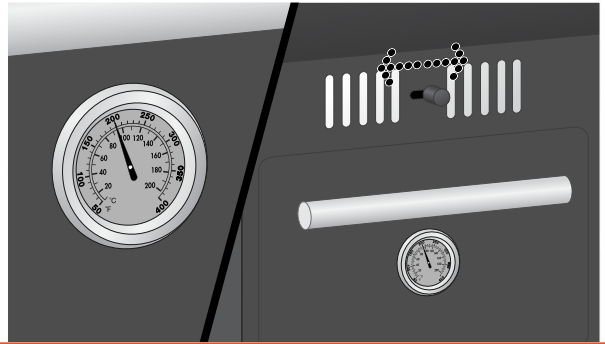

The warming drawer has its own temperature gauge on the front of the door. To regulate the heat in the drawer, simply adjust the louvered vent above the drawer. When the grill is at a higher temperature, open the vent to allow hot air to escape, reducing heat in the compartment. When the grill is at lower temperatures, keep the vent closed for maximum warming.

NOTE: The warming drawer is for keeping your food warm only. Do not place uncooked food in warming drawer for cooking, as it does not provide sufficient heat to fully cook food.

OPERATING TIPS

1. You can change the temperature dial at any time during grilling to increase or decrease cooking temperature. The HIGH temperature setting is for grilling. The SMOKE setting is for smoking and adding smoke flavor to foods being cooked. The SMOKE setting can also be used to “hold” foods at about 73.89°C / 165°F.
2. When you change the temperature using the temperature dial, the new temperature will blink 5 times, then revert back to the actual grill temperature, making it easy to know the exact grill setting.
3. **WARNING!** Your Traeger Grill should never be moved while it is hot. If you are transporting your grill in a vehicle after cooking on it, make sure the fire is completely out and the grill is **cold** before placing it in any vehicle. **Never** put water into the firepot; it will jam the auger.
4. Your Traeger Grill is designed to operate with the door closed. Cooking with the door open greatly lengthens your cooking time.
5. **CAUTION!** Never add pellets by hand to a hot firepot. This is dangerous and you may be seriously burned. If you run out of pellets and lose your fire while cooking, let the grill cool completely and start again with the “INITIAL FIRING INSTRUCTIONS” on page 10.
6. **CAUTION!** Make sure the upper heat baffle is properly seated on its locating brackets. The sides of the heat baffle should be pointing down over the firepot. If not seated properly, direct heat and flame could come up out of the firepot and cause a grease fire in the grill.
7. Always take into account the outside temperature when estimating cooking times. If it is hot outside, it will take less time for your grill to reach the set temperature. If it is cold, wet, or windy, it will take longer.
8. **Digital Elite Controller Functions:**

After selecting your cooking temperature, the auger will operate continuously until the selected temperature is reached. From that point forward, the digital control will cycle the auger off and on to maintain the selected temperature until the temperature dial is changed.

WARNING! If the fire in the firepot goes out while smoking/cooking and there are sufficient pellets still in the pellet hopper, it is important to follow these steps. Failure to do so may cause a hazardous “over-firing” of your grill due to an excess of unburned pellets in the firepot.

 - a. **DANGER!** Turn the switch OFF (O) and disconnect the power cord. Allow the grill to cool thoroughly. Open the door and remove all food, the porcelain-coated grill grates, the grease drain pan, and the upper heat baffle.
 - b. **WARNING!** Remove all unburned pellets and ash from inside and around the firepot. (See instructions for proper handling and disposal of ash on page 19.)
 - c. Before replacing the lower and upper heat baffles, grease drain pan, and the porcelain-coated grill grates, plug the power cord into an appropriate grounded electrical outlet and turn the switch ON (I). Pellets should fall into the firepot and the hot rod should begin to heat (it will start to turn red). **CAUTION! Do not touch the hot rod.**
 - d. When flames start to come out of the firepot, turn the switch OFF (O). Let the grill cool down. Now you’re ready to place the lower and upper heat baffles, grease drain pan, and porcelain-coated grill grates back into the grill. With the door open, turn the switch ON (I) and turn the temperature dial to SMOKE. In about 2 minutes, the pellets will ignite and whitish-gray smoke will come out of the grill. After the pellets have ignited, close the door and turn the temperature dial to any cooking setting desired.

OPERATING TIPS (cont.)

9. CARBON MONOXIDE:

WARNING! Follow these guidelines to prevent this colorless, odorless gas from poisoning you, your family, or others.

- Know the symptoms of carbon monoxide poisoning: headaches, dizziness, weakness, nausea, vomiting, sleepiness, and confusion. Carbon monoxide reduces the blood's ability to carry oxygen. Low blood oxygen levels can result in loss of consciousness and death.
- See a doctor if you or others develop cold- or flu-like symptoms while cooking or in the vicinity of this appliance. Carbon monoxide poisoning, which can easily be mistaken for a cold or flu, is often detected too late.
- Alcohol consumption and drug use increase the effects of carbon monoxide poisoning.
- Carbon monoxide is especially toxic to mother and child during pregnancy, infants, the elderly, smokers, and people with blood or circulatory system problems, such as anemia or heart disease.

- 10. CAUTION!** Grease fires are caused by not properly maintaining the grill by failing to clean the grease drain pan, V-shaped grease drain, and grease drain tube on a consistent basis. (See MAINTAINING YOUR GRILL for instructions.) In the unlikely event of a grease fire while cooking, turn the switch OFF (●) to reduce the amount of oxygen in the cooking chamber and keep the door closed until the fire is completely out. Never keep the door open during a grease fire. If the fire does not go out, lightly sprinkle baking soda on the fire.

CAUTION! Be careful not to burn yourself.

If this does not work, carefully remove the food from the grill and keep the door closed until the fire is completely out. **Again, be careful not to burn yourself.** When the grill is completely cool, remove the porcelain-coated grill grate and replace the foil on the grease drain pan. Clean any grease accumulation from the V-shaped grease drain and the grease drain tube. Replace the grease drain pan and the porcelain-coated grill grates in their proper positions, restart the grill, and resume cooking.

HOPPER CLEAN-OUT

Your Traeger Grill has a hopper clean-out system that allows you to quickly change from one pellet flavor to another without making a mess.

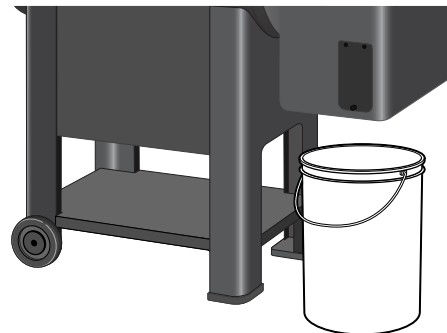
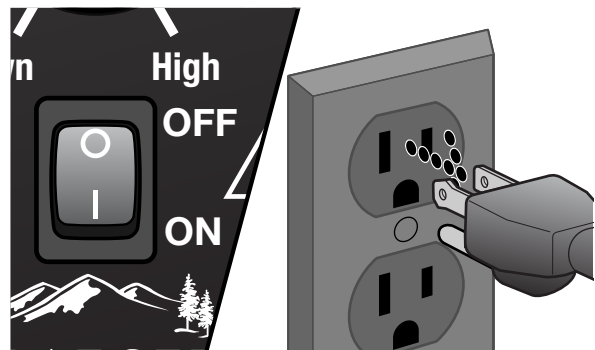

- 1 Turn the switch to OFF (O) and disconnect the power cord. If the grill is still hot, allow it to cool completely.

- 2 Place a container large enough to hold the discarded pellets under the pellet clean-out door. **TIP:** a clean 5-gallon bucket works great!

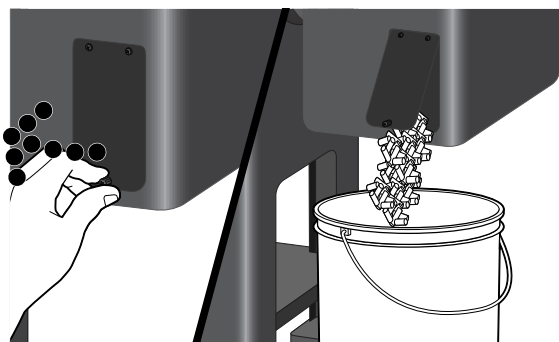

- 3 Unscrew the clean-out door fastener and open, allowing the pellets to empty into the container below it. You might need a spatula or spoon to push the remaining pellets out of the hopper.

- 4 Once the hopper's empty, close the door, replace the fastener, and refill the hopper with a different flavor of Traeger Hardwood Pellets.

MAINTAINING YOUR GRILL

1. CREOSOTE AND GREASE FORMATION AND REMOVAL

When wood pellets are burned slowly, they produce tar and other organic vapors that combine with expelled moisture to form creosote. The creosote vapors condense in the relatively cool flue exhaust of a slow-burning fire. As a result, creosote accumulates on the flue lining. When ignited, creosote makes an extremely hot fire. Airborne grease particles will travel through the cooking chamber, and some of this airborne grease will accumulate on the flue lining, similar to creosote, which could be contributory to a fire. The smokestack exhaust should be inspected at least twice a year to determine when a creosote and/or grease buildup has occurred.

Also, grease drippings from the food will fall onto the grease drain pan and be channeled into the grease drain and then out of the grill through the grease drain tube, to be collected in the grease bucket. Grease will accumulate in all of these locations.

The grease drain, the grease drain tube, and the grease bucket should be inspected at least twice a year for signs of grease buildup.

When creosote or grease has accumulated, it should be removed to reduce the risk of fire.

Cleaning the Smokestack Flue Pipe:

DANGER! Turn the switch OFF (O) and disconnect the power cord.

CAUTION! Make sure that the grill is cold before cleaning the flue pipe. Remove (unscrew) the chimney cap assembly from the top of the flue pipe. Once the chimney cap assembly has been removed, it can be cleaned with warm, soapy water or with a biodegradable degreaser.

Scrape the creosote and grease accumulation from the inside of the vertical and horizontal sections of the flue pipe using a stiff, nonmetallic tool. A wooden paint stir stick, for example, would work for this task. Once the creosote and grease residue have been loosened from the flue pipe lining, much of it can be removed with paper towels or disposable rags. Do not spray water or other liquid cleaners onto the inside of your grill. Once the flue pipe has been cleaned, replace the chimney cap assembly.

Cleaning grease from your grill:

DANGER! Turn the switch OFF (O) and disconnect the power cord.

CAUTION! Accumulated grease is easier to clean off when the grill is still warm—not hot. Be careful not to burn yourself. Gloves are recommended.

Periodically clean the grease out of the V-shaped grease drain and grease drain tube. If too much grease is allowed to build up in the V-shaped grease drain or is allowed to plug the grease drain tube, a grease fire could result. We recommend cleaning these locations regularly.

Remove the porcelain-coated grill grates and the grease drain pan. This will provide access to the V-shaped grease drain and grease drain tube opening inside the grill. Scrape the grease accumulation from inside the V-shaped grease drain and grease drain tube using a stiff, nonmetallic tool. Much of the loosened grease can be pushed down through the grease drain tube and will fall into the grease bucket. Wipe up remaining grease residue with paper towels or disposable rags. Paper towels or disposable rags can also be used to wipe some of the grease off of the interior surfaces of the grill.

Line your grease bucket with aluminum foil for easy cleanup. Empty it occasionally, depending on the amount of use. Change the aluminum foil on the grease drain pan frequently (sometimes after each use, depending upon what was cooked). Clean foil on the grease drain pan will make your food taste better and reduce the risk of a grease fire.

Cleaning outside surfaces:

DANGER! Turn the switch OFF (O) and disconnect the power cord.

Use a disposable rag or cloth dampened with warm, soapy water to wipe the grease from the outside of the grill. DO NOT use oven cleaner, abrasive cleansers, or abrasive cleaning pads on the outside grill surfaces.

Outside storage:

CAUTION! If the grill is stored outside during the rainy season, care should be taken to ensure that water does not get into the pellet hopper. Wood pellets expand greatly when wet and will jam your auger. Your Traeger Grill comes with a custom cover to protect it from the elements.

Cleaning the porcelain-coated grill grates:

CAUTION! Cleaning the porcelain-coated grill grates works best while they are still warm. Be careful not to burn yourself. After removing your food, clean the porcelain-coated grill grates with a cleaning brush or other similar tool. It takes only a minute and it will be ready the next time you want to use the grill.

2. ASH CLEANING AND REMOVAL

Cleaning the ash from inside and around the firepot:

DANGER! Turn the switch OFF (O) and disconnect the power cord.

WARNING! Make sure that the grill is **cold** before cleaning the ash.

WARNING! Disposal of ashes should be done only according to the following instructions.

Excess ash in the firepot may cause your fire to go out, especially on the SMOKE setting. The firepot should be inspected occasionally and cleaned to remove the ash buildup. Again, cleaning the ash from in and around the firepot should be done only when the grill is **cold**.

Remove the porcelain-coated grill grates, grease drain pan, and heat baffle to provide access to the firepot and the interior of the grill. Much of the ash outside of the firepot can be removed from the grill with a small metal fireplace shovel or other similar tool.

Dispose of the ashes according to the following instructions.

WARNING! A shop vac is the best way to remove ashes from the firepot, but this must be done with extreme care to avoid the risk of fire. Again, cleaning the ash from the firepot should be done only when the grill is **cold**.

A utility-type vacuum cleaner having a metal collection canister without a bag would be best for this task. However, almost any vacuum cleaner will work safely if this procedure is properly followed.

After ensuring that the ash in the firepot is **cold**, vacuum the ash from the inside of the firepot.

- a. If your vacuum cleaner is a bagless model, empty any previously accumulated debris from the collection chamber. Then vacuum the ash from the inside of the firepot. Once the firepot is clean, empty the collection chamber into the metal container described below without delay. Make sure that there is no remaining ash residue left in the collection chamber.
- b. If your vacuum cleaner is a model that uses a disposable bag, install an unused bag in the machine. Then vacuum the ash from the inside of the firepot. Once the firepot is clean, remove the bag from the vacuum cleaner and place it in the metal container described below without delay.

DISPOSAL OF ASHES:

WARNING! Ashes should be placed in a metal container with a tight-fitting lid. The closed container of ashes should be placed on a noncombustible floor or on the ground, well away from all combustible materials, pending final disposal. Ashes are disposed of by burial in soil or otherwise locally dispersed.

REIGNITING YOUR GRILL

WARNING! If at any time the grill fails to light or the fire in the firepot goes out while cooking or smoking and there are sufficient pellets in the pellet hopper, it is important to follow these steps. Failure to do so may cause a hazardous "over-firing" of your grill due to an excess of unburned pellets in the firepot.

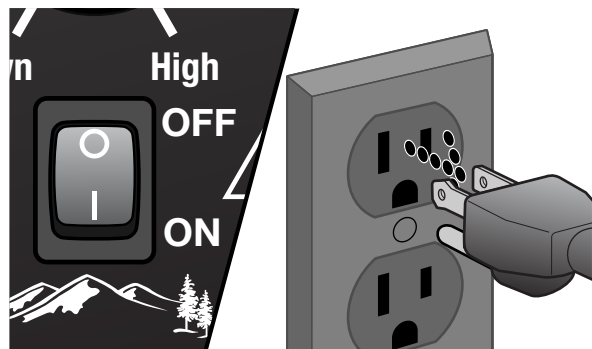

1 **DANGER!** If the grill failed to light or the fire went out, turn the switch OFF (O) and disconnect the power cord. If the grill is still hot, allow it to cool thoroughly.

2 Open the door and remove all food, the porcelain-coated grill grates, the grease drain pan, and the upper and lower heat baffles.

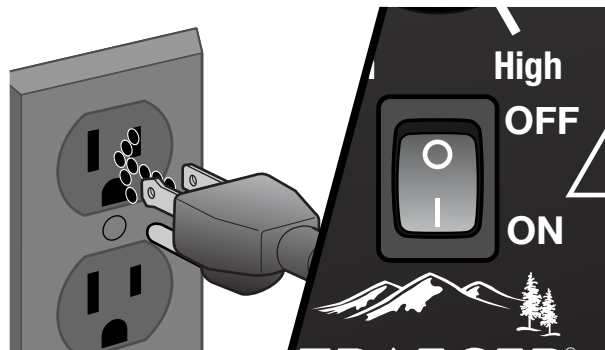
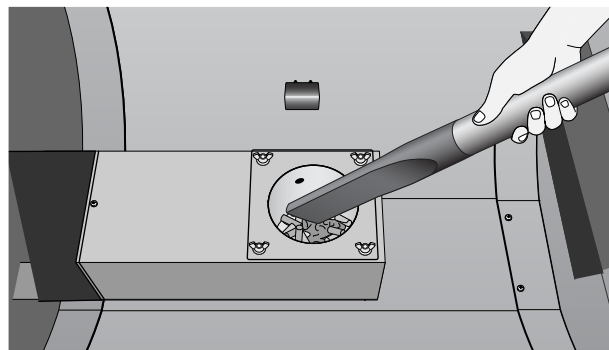

3 **WARNING!** Remove all unburned pellets and ash from inside and around the firepot. (See instructions for proper handling and disposal of ash on page 19.)

4 Plug power cord into an appropriate grounded electrical outlet and restart the grill. Pellets should fall into the firepot and the hot rod should begin to heat (it will start to turn red). **CAUTION! Do not touch the hot rod.**



5

When flames start to come out of the firepot, turn the switch OFF (O). Let the grill cool down. Now you're ready to place the upper and lower heat baffles, grease drain pan, and porcelain-coated grill grates back into the grill.



6

With the door open, turn the switch ON (I) and the temperature dial to SMOKE. In about 2 minutes, the pellets will ignite and whitish-gray smoke will come out of the grill. After the pellets have ignited, close the door and turn the temperature dial to any cooking setting desired.

NOTE: If the procedure **is not** successful, see "FREQUENTLY ASKED QUESTIONS" on page 22 for troubleshooting tips or contact Traeger's VIP-365 Customer Service (see page 26) to help diagnose the problem.

FREQUENTLY ASKED QUESTIONS

Question	Answer		
Why won't my grill ignite?	Verify power at the electrical outlet.	If the power cord is connected to a GFCI (ground fault circuit interrupter), check and reset if necessary. Initiate start-up. If no ignition, see next answer.	
	DANGER! Turn the switch OFF (O) and disconnect the power cord.	Remove the control and check the fuse on back. Replace the fuse if blown. REINSTALL THE CONTROL.	
	Check the draft inducer fan and the auger drive motor for operation. If both are operating, the hot rod needs to be replaced. If one or both are not operating, contact Traeger's VIP-365 Customer Service (see page 26) for additional troubleshooting help or to place an order.		
	Why are no pellets being delivered into the firepot?		
Verify that there are pellets in the pellet hopper. If this is the initial firing or the grill has run out of pellets, allow sufficient time for the pellets to travel from the pellet hopper to the firepot (can take up to 7 minutes).			If there are still no pellets in the firepot, proceed to next answer.
Initiate start-up. See "INITIAL FIRING INSTRUCTIONS" on page 10.			If there are still no pellets in the firepot, proceed to next answer.
If the auger drive motor is operating (check the small fan blade on the back of the motor), the problem is in the digital control, which will need to be replaced. Contact your Traeger dealer or Traeger's VIP-365 Customer Service (see page 26) to place an order.			
If the auger drive motor is not operating but the draft inducer fan is operating, the problem is in the auger system, which will need to be checked.			With the switch OFF (O), locate the small fan blade on the back of the auger drive motor.
CAUTION! While watching the fan blade, turn the switch ON (I). If the fan blade does not turn, turn the switch OFF (O). This indicates a defective auger drive motor, and it will need to be replaced. Contact your Traeger dealer or Traeger's VIP-365 Customer Service (see page 26) to place an order.			
If the fan blade turns a bit and then stops, continue watching and turn the switch OFF (O). If the fan blade UNWINDS slightly, this indicates a jam in the auger system which will need to be cleared.			
DANGER! Turn the switch OFF (O) and disconnect the power cord. Remove the pellets from the pellet hopper. Check for foreign objects and wet or decomposed pellets, both of which can cause a jam in the auger system. The auger will need to be removed to clear a jam in the auger system. See "How do I remove the auger if it jams?" section on page 23.			

Question	Answer	
<p>How do I remove the auger if it jams?</p>	<p>DANGER! Turn the switch OFF (O) and disconnect the power cord.</p>	
	<p>CAUTION! If the grill is still hot, allow it to cool thoroughly.</p>	
	<p>Remove any covers necessary to access the auger drive motor.</p>	
	<p>Remove the screw connecting the auger drive motor shaft to the auger shaft and the screw retaining the auger bushing into the auger tube.</p>	
	<p>With a small pipe wrench or locking pliers on the auger shaft, turn the auger counterclockwise. It will turn hard until it breaks free; then the auger will turn freely.</p>	
	<p>Remove the auger and clean all pellets, ash, or foreign objects from the auger, auger tube, and firepot. (See instructions for proper handling and disposal of ash on page 19.)</p>	
	<p>Sand the outside surfaces of the auger with medium grit sandpaper. Check the inside of the auger tube and sand it if needed. Vacuum the sanding grit out of the auger tube and firepot when finished. Check that the auger rotates freely.</p>	
<p>Reattach the auger shaft to the auger drive motor shaft.</p>		
<p>Why does my grill fire go out on SMOKE setting?</p>	<p>There may be excess ash in the firepot which needs to be cleaned.</p>	
	<p>WARNING! If the fire in the firepot goes out while smoking and there are sufficient pellets in the pellet hopper, it is important to follow these steps. Failure to do so may cause a hazardous “over-firing” of your grill due to an excess of unburned pellets in the firepot.</p>	<p>DANGER! Turn the switch OFF (O) and disconnect the power cord. Allow the grill to cool thoroughly. Open the door and remove all food, the porcelain-coated grill grate, the grease drain pan, and the upper heat baffle.</p>
		<p>WARNING! Remove all unburned pellets and ash from inside and around the firepot. (See instructions for proper handling and disposal of ash in on page 19.)</p>
		<p>Before replacing the upper heat baffle, grease drain pan, and porcelain-coated grill grate, plug the power cord into the appropriate grounded electrical outlet and turn the switch ON (I). Pellets should fall into the firepot and the hot rod should begin to heat (it will start to turn red). CAUTION! Do not touch the hot rod.</p>
		<p>When flames start to come out of the firepot, turn the switch off (O). Let the grill cool down. Now you’re ready to place the upper heat baffle, grease drain pan, and porcelain-coated grill grate back into the grill. With the door open, turn the switch ON (I) and turn the temperature dial to SMOKE. In about 2 minutes, the pellets will ignite and whitish-gray smoke will come out of the grill. After the pellets have ignited, close the door and turn the temperature dial to any cooking setting desired.</p>
<p>If this does not fix the problem, contact Traeger's VIP-365 Customer Service (see page 26) for assistance.</p>		

FREQUENTLY ASKED QUESTIONS (cont.)

Question	Answer
<p>With the Traeger Digital Elite Controller, what dial setting is recommended for starting the grill?</p>	<p>The auto-start procedure is the same for all grill controls. With the door open, turn the switch ON (I) and turn the temperature dial to SMOKE. In about 2 minutes, the pellets will ignite and whitish-gray smoke will come out of the grill. After the pellets have ignited, close the door and turn the temperature dial to any cooking setting desired.</p>
<p>How do I protect my paint finish?</p>	<p>Use the protective cover on the grill and touch-up paint to repair any scratches. Touch-up paint is available from your Traeger dealer, or log onto our website, traegergrills.com.</p>
<p>Where can I get a new part for my grill?</p>	<p>Every 90 days, use a high-quality car wax on the outside surfaces of the grill. ONLY APPLY WAX TO A COLD GRILL.</p>
	<p>Check with your Traeger dealer. They may have the part in stock or can order the part for you.</p> <p>Contact Traeger's VIP-365 Customer Service (see page 26) to place an order.</p> <p>In either case, please provide your name, phone number, address, model, and serial number of the grill (located on the label inside the hopper lid), along with the part identification number from the component diagram or parts list.</p>

WIRING DIAGRAM

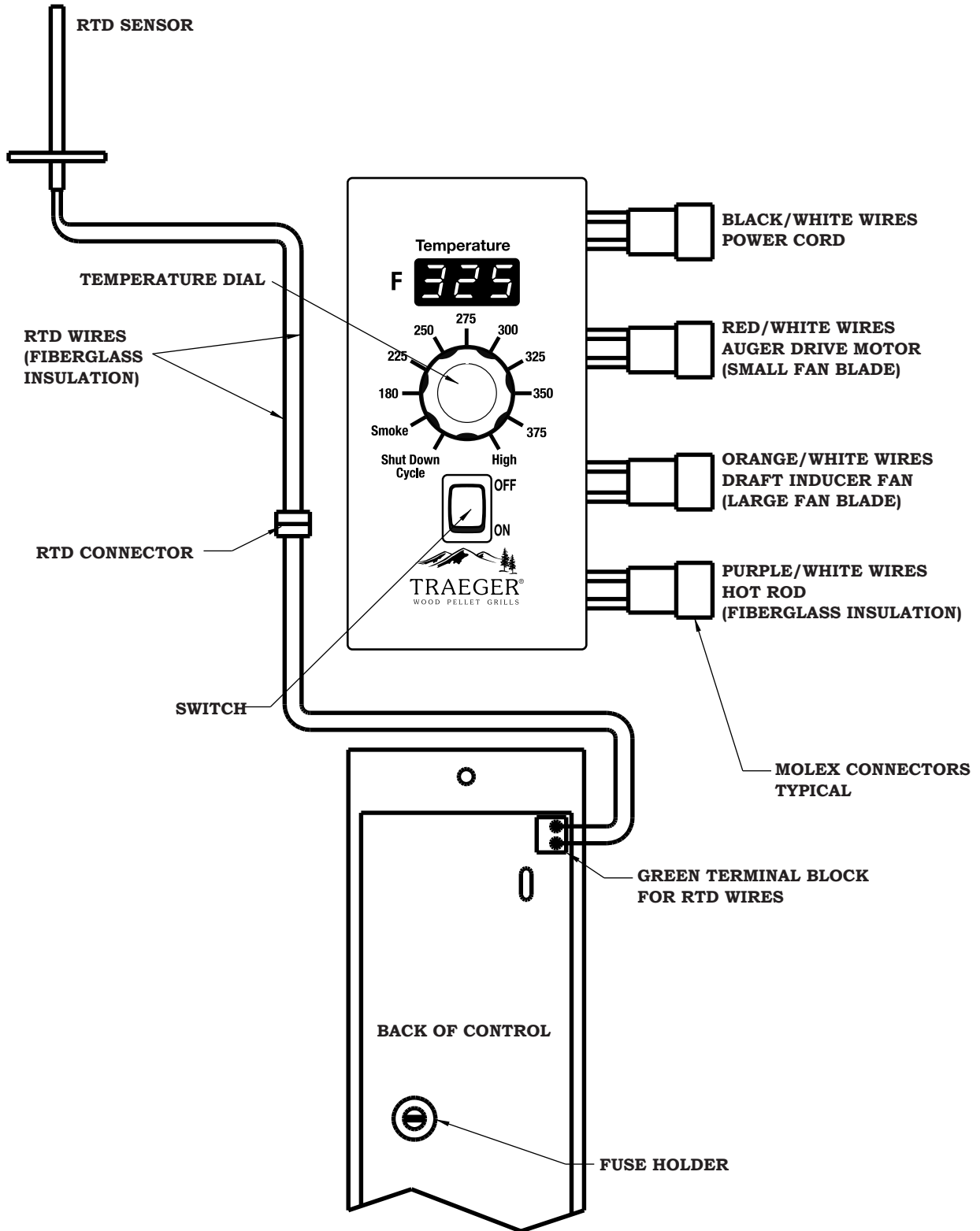



TRAEGER'S LEGENDARY VIP-365 customer service is the best out there. If you have any questions about your Traeger grill or need tips on cooking your first Thanksgiving turkey, our seasoned experts have your back. We're here for you 365 days a year including holidays, because we're cooks — not bankers.

For 24/7 assistance with assembly or installation, parts, and customer service (English only, please), you can phone, email, or write us at:

TRAEGER'S VIP-365 CUSTOMER SERVICE

By Phone: 1-800-TRAEGER
Email: service@traegergrills.com

TRAEGER PELLET GRILLS LLC

1215 E. Wilmington Ave
Salt Lake City, UT 84106



3-YEAR WARRANTY

Traeger Pellet Grills LLC warrants this barbecue grill against defects in material and workmanship under normal use and maintenance for a period of three (3) years from the date of original purchase.

Traeger Pellet Grills LLC will provide a replacement part for any part found to be defective. Original part(s) approved for return by Traeger's Parts Department must be returned prepaid.

This warranty does not include labor charges connected with the determination or replacement of defective parts, or freight charges to ship these parts.

Traeger Pellet Grills LLC shall not be liable under this or any implied warranty for incidental or consequential damages. This warranty gives the retail customer specific legal rights and the customer may have other rights which vary from state to state.

This warranty shall be void if the unit is not assembled or operated in accordance with the operation instructions provided with this unit; the unit is resold or traded to another owner; components, or accessories not compatible with the unit have been used; the unit has been used in a commercial or food service application; or the user has abused or otherwise failed to maintain the unit.

To process a warranty claim, Traeger Pellet Grills LLC may require proof of your date of purchase. You should retain your sales slip or invoice along with this certificate with your valuable documents.