



OWNER'S MANUAL

REDLAND

WELCOME TO THE WOOD-FIRED REVOLUTION.
WE WANT YOU TO GET THE MOST OUT OF YOUR TRAERER.



Scan here to access this manual in different languages, as well as to learn how to set up, season, and get the most out of your grill.

TFB65BVH
TFB89BVH
T09627-B

FCC ID: 2AC7Z-ESP32WROVERE
IC ID: 21098-ESP32WROVERE

IMPORTANT SAFETY PRECAUTIONS

READ ALL INSTRUCTIONS BEFORE INSTALLING AND USING YOUR TRAEGER® GRILL

A MAJOR CAUSE OF FIRES IS FAILURE TO MAINTAIN REQUIRED CLEARANCES (AIR SPACES) BETWEEN COMBUSTIBLE MATERIALS AND YOUR GRILL. IT IS OF UTMOST IMPORTANCE THAT THIS PRODUCT BE INSTALLED ONLY IN ACCORDANCE WITH THESE INSTRUCTIONS.

When properly operated and maintained, cooking with a hardwood fire on a Traeger® Grill brings years of enjoyment to you and your friends and family. Your new Traeger® Grill is specially designed to make cooking easier while giving you optimal performance with the most flavorful food.

Please read this entire manual before installation and operation. Anyone who uses this grill should also read the entire manual before operating it. Failure to follow these instructions could result in property damage, bodily injury, or even death. Contact local building or fire officials about restrictions and installation inspection requirements in your area. **Save these instructions.** If you are assembling this unit for someone else, provide this manual for the owner to read and save for future reference.

⚠ DANGER Carbon Monoxide Hazard

Burning wood pellets produces carbon monoxide which may lead to illness, serious injury, and/or death. Follow these guidelines to prevent this colorless, odorless gas from poisoning you, your family, your pets, or others:

- Only use your Traeger® Grill outside in a well-ventilated area. This grill is intended for **OUTDOOR USE ONLY**.
- **Never** use your Traeger® Grill in any enclosed area or any area without adequate ventilation.
- Know the symptoms of carbon monoxide poisoning: headache, dizziness, weakness, nausea, vomiting, sleepiness, and confusion. Carbon monoxide reduces the blood's ability to carry oxygen. Low blood oxygen levels can result in loss of consciousness and death.
- See a doctor if you or others develop cold- or flu-like symptoms. Carbon monoxide poisoning, which can easily be mistaken for a cold or flu, is often detected too late.
- Alcohol consumption and drug use increase the effects of carbon monoxide poisoning.
- Carbon monoxide is especially toxic to mother and child during pregnancy, infants, the elderly, smokers, and people with blood or circulatory system problems, such as anemia or heart disease.

⚠ WARNING Fire Hazard

- When operating your Traeger® Grill, maintain a **MINIMUM** distance of 18 inches (45.7 cm) from the grill to any nearby combustibles, including wooden railings, home siding, window frames, furniture, trees, and trash receptacles, etc.

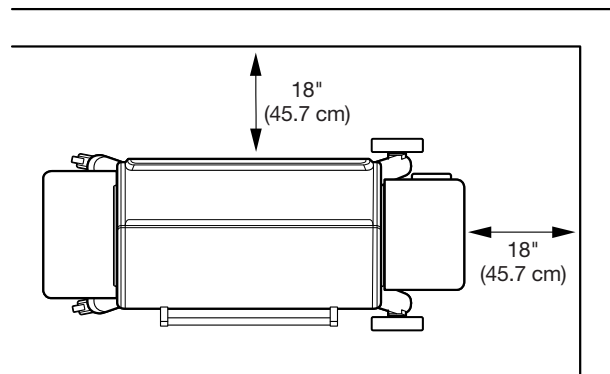

- Do not install or operate this grill indoors or under a combustible ceiling or overhang.
- Do not install or operate your Traeger® Grill on combustible floors or surfaces.
- Remove pots and pans while the operating appliance is unattended, to reduce the risk of fire.

⚠ WARNING Fire Hazard

- Keep your Traeger® Grill clean. Grease fires are caused by not properly maintaining your grill and failing to clean its Traeger® Grease Management System on a consistent basis (see "Maintaining Your Grill" on pages 30-31).



- Even if there is ample room in the grill, be cautious of loading excessive amounts of food or high fat content foods (e.g., bacon) that can release large quantities of flammable grease.
- Do not place food near the edges of the grill where grease drippings may miss the grease drip tray and fall to the bottom of the grill, where they could come into contact with embers from the firepot and ignite.
- Always make sure the heat baffle and drip tray are properly seated on their locating brackets. If not installed correctly, direct heat and flame from the firepot could cause a grease fire or damage the Traeger® Grease Management System.
- **Never** use gasoline, lantern fuel, kerosene, lighter fluid, or other flammable materials to start or “freshen up” a fire.
- **Never** use or store flammable liquids or other combustibles materials near the grill.
- **Never** attempt to over-fire your grill by adding excess pellets or other combustible materials to the firepot or the hopper.

▲ DANGER In the event of a grease fire, ensure the grill door and hopper lid are closed, and then immediately unplug the grill if you can do so safely. Move away from the grill until the fire is completely out and grill has cooled down. Until the fire has extinguished and the grill has cooled off:

- **Do Not** move the grill;
- **Do Not** throw water on the grill;
- **Do Not** use salt or baking soda to put out a grease fire; and
- **Do Not** try to smother the fire.

With the grill door and hopper closed, the fire will be starved of oxygen and burn itself out. Never keep the grill door or hopper lid open during a grease fire; if the grill door is open, use a non-combustible tool that will allow you to close the grill door while keeping a safe distance from the grill. An all-class (class ABC) approved fire extinguisher should be used if a fire is not contained within the grill. If an uncontrolled fire does occur, immediately call the Fire Department. When the fire is completely out, allow the grill to cool completely. Remove everything from the inside of your grill, including all internal components (grill grates, drip tray, heat baffle, and firepot), pots and pans, and food. Clean the entire grill, including any grease accumulation from the Traeger® Grease Management System (TGMS) and all ash and pellets from the grill and firepot (see “Maintaining Your Grill” on pages 30-31). Replace the firepot, heat baffle, grease drip tray, and grill grates, restart the grill, and resume cooking.

▲ WARNING Fire Hazard

Always allow grill to cool completely before using the Auger function.

▲ WARNING Burn Hazard

Ashes should always be completely cool before handling. Ashes should be placed in a metal container with a tight-fitting lid. The closed container of ashes should be placed on a noncombustible floor or on the ground, well away from all combustible materials, pending final disposal. Ashes should be retained in the closed container until they are disposed.

▲ WARNING Burn Hazard

Many parts of the grill become very hot during operation. During operation of the grill and afterwards, care must be taken to avoid burns while the grill is hot.

- **Never** leave the grill unattended when young children or pets are present.
- **Never** move the grill when it is operating or hot. Let the grill cool thoroughly and close the grill door before moving or attempting to transport. If you are transporting your grill in a vehicle after cooking on it, make sure the fire is completely out and the grill is cold before placing it in any vehicle. Never put water into the firepot; it will jam the auger.
- **Never** add pellets by hand to a hot firepot. This is dangerous and you may be seriously burned. If you run out of pellets and lose your fire while cooking, let the grill cool completely and start again. (See page 27, “Hopper Clean-out” instructions).
- Grill grates and meat probes are extremely hot when preheated. Please use caution when loading food onto the grill grates and when inserting, removing, or adjusting your meat probes.
- **Never** move the grill with the door open. Always close the grill door prior to moving.

▲ WARNING Smoke Hazard

- If there is a delayed start and the smoke from your grill changes from transparent white smoke to unusual billowing thick non-transparent white smoke that turns to a yellow tinted smoke, immediately turn off your grill using the main power switch on the back of the pellet hopper or unplug the power cord. **Do Not** initiate the shut-down cycle.

- **▲ DANGER Do Not** open the grill door to air out the grill. Stay away from the grill until smoke clears and the grill completely cools.
- This may be the result of a pellet overflow condition, which is caused by partial ignition of pellets. If allowed to continue long enough, gases will build up, which can ignite. If these gases ignite they

IMPORTANT SAFETY PRECAUTIONS CONTINUED

will combust all at once, making a loud noise that may startle and/or injure persons in the immediate vicinity of the grill, and the grill door may open and close. This occurrence is sometimes referred to as a “grill burp” and should be avoided. If you have not properly maintained your grill, as described in “Maintaining Your Grill” on pages 30-31, a hazardous grease fire may also result.

- If a burp occurs, let the grill cool down completely, remove all internal components (including grill grates, drip tray, heat baffle, and firepot), and thoroughly clean all ash and pellets from the grill and firepot (see page 31, “Cleaning the Ash from Inside and Around the Firepot”) and ensure that grease and other buildup has been removed (see pages 30-31, “Maintaining Your Grill”). Remove all pellets from the pellet hopper. Run the prime auger sequence to push all pellets out of the auger and dispose of those pellets. Clean all pellets out of the firepot. Fill hopper with new pellets and prime the auger (See “Seasoning Your Grill” on page 14 for instructions on priming your auger).
- **▲ DANGER** Do Not stick your hand in or near the auger located at the bottom of your pellet hopper. Severe injury will occur if the auger is turning and your hand is caught in the auger. Do not remove the wire guard in your pellet hopper. No maintenance should be performed on or around the auger while the grill is turned on or plugged into power.

▲ WARNING Electrical Shock Hazard

Hazardous voltage is present, which can shock, burn, or cause death.

- Ground Fault Circuit Interrupter (GFCI) protection must be provided on the circuit(s) or outlet(s) to be used for the operation of this Traeger® Grill.
- Disconnect the power cord before servicing the grill unless otherwise noted in this Owner’s Manual.
- If using an extension cord, only use an extension cord suitable for outdoor use to prevent electric shock in accordance with the instructions and warnings accompanying that product. This type of cord is designated with “W-A” or “W” on the cord’s jacket, such as an extension cord of cord type: SW-A, SOW-A, STW-A, STOW-A, SJW-A, SJOW-A, SJTW-A, or SJTOW-A.
- If using an extension cord, be sure to use a No. 14 AWG grounded extension cord.
- Do not modify the plug on your Traeger® Grill, the extension cord receptacle, or the extension cord plug in any way, including by removing the ground (earth) prong.

- Make sure your extension cord is in good condition. Inspect extension cords prior to each use for loose or exposed wires and cut or worn insulation. Replace if damaged. Never use a damaged extension cord.
- Ensure that the power cord and extension cord are securely plugged together. Do not plug extension cords into one another.
- Keep extension cord clear of snow and standing water.
- Ensure that the power cord and extension cord do not create a tripping hazard. Do not route an extension cord through a window or doorway.
- When not in use, the extension cord should be removed and stored in a location protected from the sun and out of the reach of children.

▲ CAUTION

- Never modify this grill or install any parts or components not authorized by Traeger for use with this grill. Any modification of this grill or installation of unauthorized parts or components will void the warranty and may create a safety hazard including, without limitation, a fire.
- Children should be supervised to ensure they do not play with the grill.
- Do not put a grill cover or anything flammable in the storage space area under the grill.

▲ CAUTION Use Correct Pellets

- This grill is designed and approved only for all-natural wood cooking pellets designed for wood pellet grills. Use of any other type of fuel in this grill will void the warranty, may lead to the auger becoming jammed, and may create a safety hazard.
- **For best results and flavor, use genuine TRAEGER® BRAND HARDWOOD PELLETS.**
- Always store wood pellets in a dry location, away from heat-producing appliances and other fuel containers.

▲ WARNING Do not use fuel pellets. Never use heating fuel pellets in the grill because they may contain hazardous contaminants and additives and may damage the grill.

▲ CAUTION Minimum Ambient Temperature

- When the ambient temperature falls below -20°F (-29°C), damage to the controller’s display may occur.

▲ WARNING Improper placement of the meat probe or improper meat probe calibration could result in raw or undercooked meats, which may increase your risk of foodborne illness.



▲ WARNING If the fire in the firepot goes out while cooking, it is important to follow these steps. Failure to do so may cause a hazardous “overfiring” of your grill due to an excess of unburned pellets in the firepot. This is often caused by improper start-up procedure and/or running out of pellets.

- Turn the main power switch in the back of the grill hopper to OFF (O) and disconnect the power cord. Allow the grill to cool thoroughly. Open the door and remove all food, grill grates, drip tray, and heat baffle.
- Remove all unburned pellets and ash from inside and around the firepot. (See instructions for proper handling and disposal of ash on page 31.)
- Before replacing the heat baffle, drip tray, and grill grates, plug the power cord into an appropriate grounded/earthed electrical outlet and turn the main power switch to ON (I). Pellets should fall into the firepot and the hot rod should begin to heat (it will start to turn red). **▲ WARNING** Do not touch the hot rod.
- When flames start to come out of the firepot, turn the main power switch to OFF (O). Let the grill cool down. Now you’re ready to place the heat baffle, grease drip tray, grill grates, and food back into the grill.

▲ WARNING

- Turn the main power switch to OFF (O) and disconnect the power cord before initiating any maintenance.
- Accumulated grease is easier to clean off when the grill is still warm—not hot. **Be careful not to burn yourself. Heat-protective gloves are recommended.**

- A dedicated vacuum cleaner is the best way to remove ashes from the firepot, but this must be done with extreme care to avoid the risk of fire. Again, cleaning the ash from in and around the firepot should be done only when the grill is COLD.
- Cleaning the grill grates works best while they are still warm. **Be careful not to burn yourself. Heat-protective gloves are recommended.** We recommend keeping a long-handled cleaning brush near the grill. After removing your food, give the grill grate a quick brushing. It takes only a minute and it will be ready the next time you want to use the grill.

This equipment has been tested and found to comply with the limits for Class B digital device, pursuant to part 15 of the FCC Rules. These limits are designed to provide reasonable protection against harmful interference in a residential installation. This equipment generates, uses, and can radiate radio frequency energy and, if not installed and used in accordance with the instructions, may cause harmful interference to radio or television reception, which can be determined by turning the equipment off and on. The user is encouraged to try to correct the interference by one or more of the following measures:

- Reorient or relocate the receiving antenna.
- Increase the separation between the equipment and the receiver.
- Connect the equipment into an outlet on a circuit different from that to which the receiver is connected. Consult the dealer or an experienced radio/TV technician for help.
- For additional information please contact Traeger’s Compliance Engineer at compliance@traeger.com or 1215 E. Wilmington Ave, Suite 200, Salt Lake City, UT 84106

This device complies with Part 15 of the FCC rules. Operation is subject to the following conditions: (1) This device may not cause harmful interference, and (2) this device must accept any interference received, including interference that may cause undesired operation

SAVE THESE INSTRUCTIONS

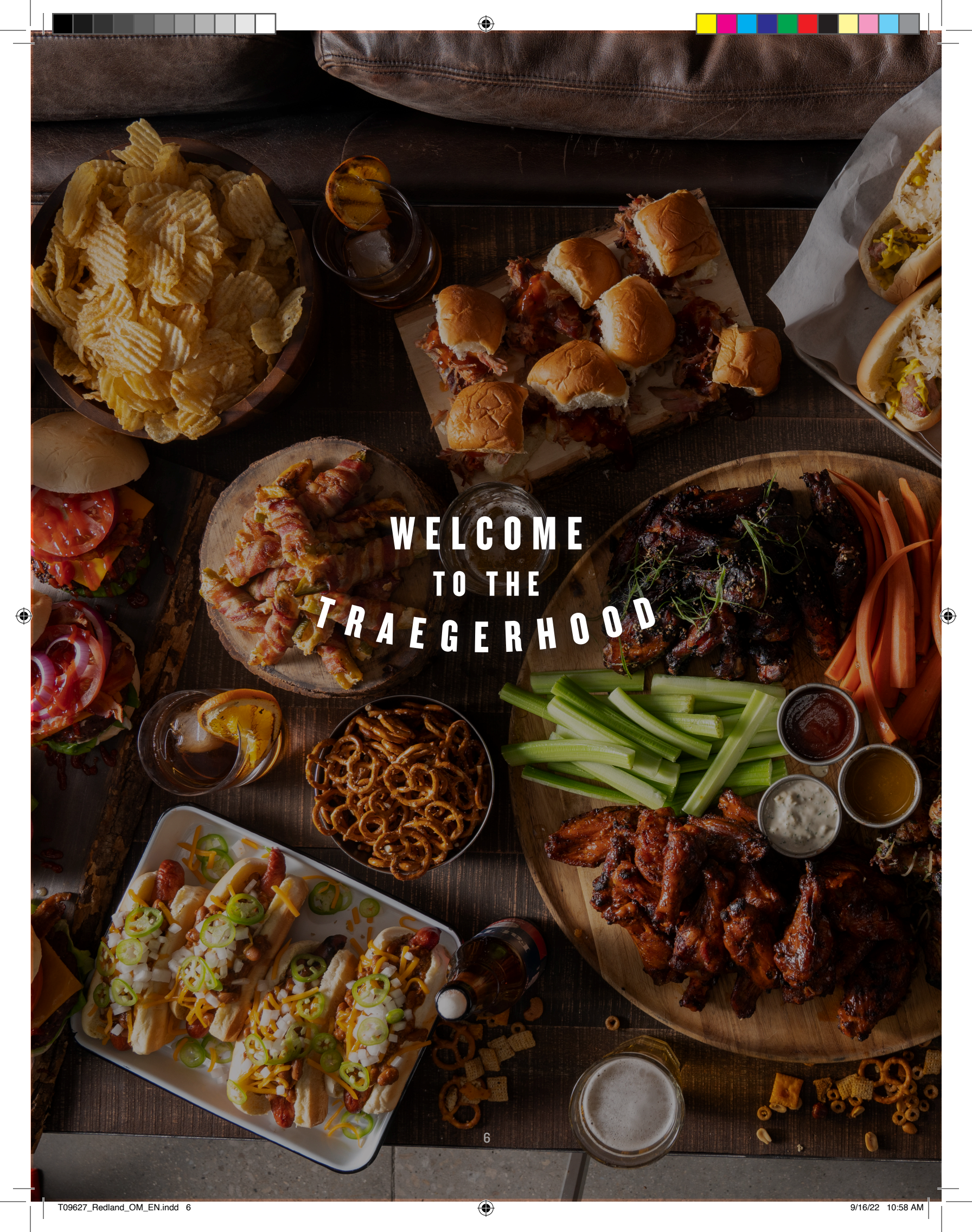

WELCOME
TO THE
TRAEGERHOOD

TABLE OF CONTENTS

- 2 IMPORTANT SAFETY PRECAUTIONS
- 8 FLAVOR MATTERS
- 10 GETTING TO KNOW YOUR GRILL
- 14 SEASONING YOUR GRILL
- 16 USING YOUR GRILL
- 18 CHOOSING A COOK METHOD
- 26 ADDITIONAL CONTROL FUNCTIONS
- 27 HOPPER CLEAN-OUT
- 28 GRILL FEATURES
- 30 MAINTAINING YOUR GRILL
- 32 TROUBLESHOOTING
- 35 OPERATING TIPS
- 36 SERVICE
- 38 WARRANTY

FLAVOR MATTERS. WOOD ISN'T JUST THE FUEL, IT'S THE **SECRET INGREDIENT.**

**TRAEGER
HARDWOOD**

**GOOD FOR ANYTHING
GREAT FOR:**

FLAVOR	BEEF	CHICKEN	PIG	SEAFOOD	VEGETARIAN	FRUIT
APPLE		🐔	🐷		🍞	🍏
CHERRY	🐮	🐔	🐷		🍞	
HICKORY	🐮	🐔	🐷			🍏
MESQUITE	🐮	🐔		🦞		
PECAN	🐮	🐔	🐷		🍞	🍏
SIGNATURE BLEND	🐮	🐔	🐷	🦞	🍞	🍏

THE PERFECT **PAIRINGS**



Bold cuts of beef need bold wood flavors to match, like hickory or mesquite.



Throw in some pellets and turn your Traeger into a wood-fired pizza oven.



Cherry pie cooked over fruit hardwood pellets? Yes please.

NO FILLERS
BINDERS
NO WORRIES



MADE IN THE U.S.A.

ALL NATURAL HARDWOOD PELLETS

CONSISTENT PERFORMANCE & FLAVOR

HOW OUR PELLETS ARE MADE



1 Traeger pellets are made from **all natural hardwood** sawdust.



2 The sawdust is compressed into pellets using **heat and pressure**.



3 Pellets **fuel the fire and add flavor** to make meals unforgettable.

GETTING TO KNOW YOUR GRILL

Refer to the Assembly Guide to assemble and install your Traeger® Grill.

PARTS AND FEATURES

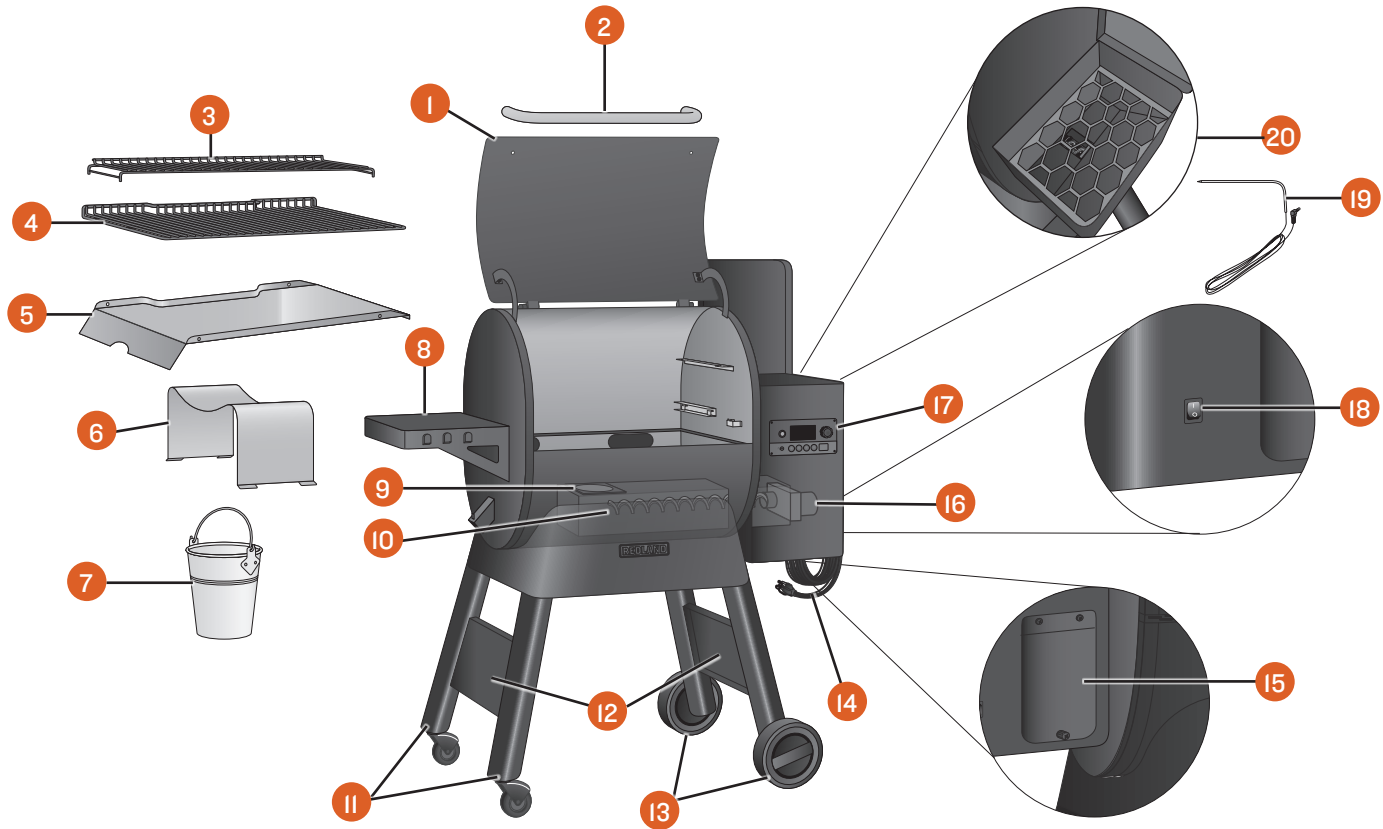

PART	DESCRIPTION	PART	DESCRIPTION
1	GRILL DOOR	11	LOCKING-CASTER LEGS
2	DOOR HANDLE	12	LEG BRACES
3	TOP GRILL GRATE	13	ALL-TERRAIN WHEEL LEGS
4	BOTTOM GRILL GRATE	14	DETACHABLE POWER CORD
5	GREASE DRIP TRAY	15	HOPPER CLEAN-OUT DOOR (BACK OF GRILL)
6	HEAT BAFFLE	16	PELLET HOPPER
7	GREASE BUCKET	17	TRAEGER CONTROLLER WITH WIFIRE® TECHNOLOGY
8	SIDE SHELF	18	MAIN POWER SWITCH (BACK OF GRILL)
9	FIREPOT	19	MEAT PROBE
10	AUGER	20	PELLET HOPPER INTERIOR WITH GRATE

PELLET HOPPER

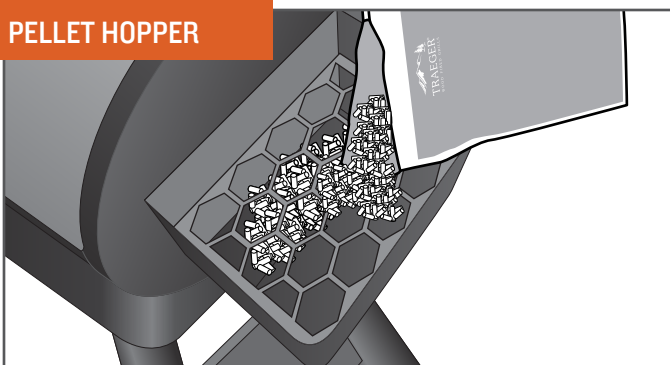

A 20-lb. (9.1 kg) capacity pellet hopper will keep you cooking for hours. Pair that with Traeger's Controller with WiFIRE® Technology and delicious food is just a "click" away.

GRILLING SPACE

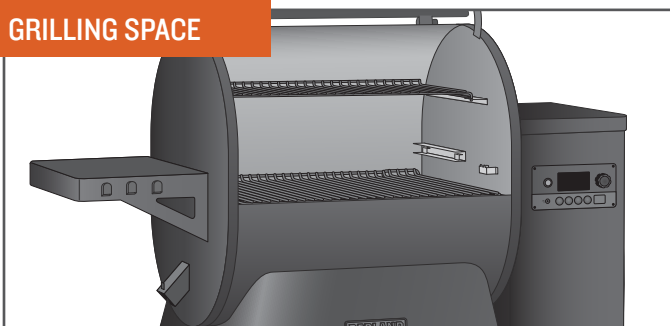

With 650-885 in.² (0.42-0.57 m²) of grilling space, your Traeger® Grill has the real estate for party-sized orders of T-bones or racks of ribs, with enough room left over to handle those side dishes, too.

VERSATILITY



An adjustable 2-tier grate system offers options to load up both grill grates for a true feast; remove the top grate for taller food like a colossal turkey, or use the bottom grate to sear for perfect grill marks.

GRILL SHAPE/DOWNDRAFT EXHAUST

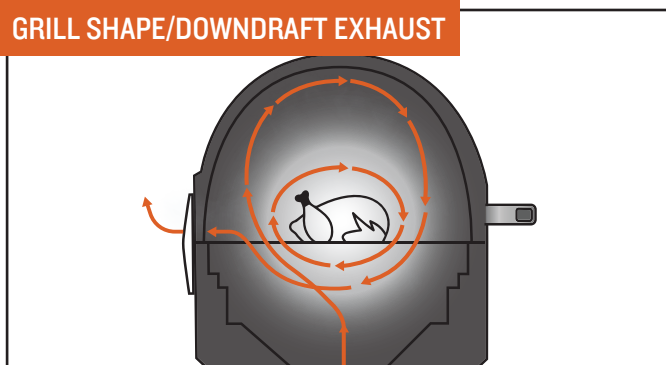

Traeger's signature grill shape/downdraft exhaust creates a vortex of convection. It circulates hot, smoky air around the cooking chamber, surrounding your food with wood-fired heat for even cooking on all sides. The smoky air is always present during cooking, even if you don't see it.

HIGH-TECH CONTROLS



With the Traeger® Grill, controlling your grill is as easy as pulling out your phone. The WiFIRE® Technology allows you to set and adjust temperatures automatically with recipes downloaded from our Traeger app. To download the app for Android, go to the Google Play Store; for Apple, go to the App Store. For information on how to use the app, go to traeger.com/app. See "Connecting Your Grill" section (page 13) for instructions on how to connect your grill to your phone.

NO FLARE-UPS

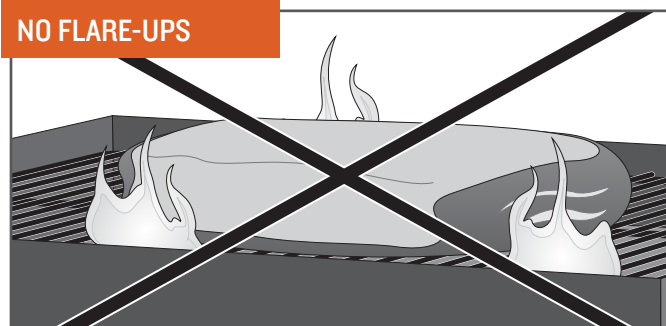

You don't have to worry about drippings flaring up and causing nasty fireballs that destroy your meal because Traeger® Wood Fired Grills cook by using indirect heat. Most drippings are safely channeled into an external grease bucket for easy disposal.

TIPS:

- Take care of your grill by using a new Traeger® drip tray liner before each cook to help keep your grill clean.
- Keep your grill clean. See "Operating Tips" (page 35) and "Maintaining Your Grill" (page 30).

GETTING TO KNOW YOUR GRILL CONTINUED

YOUR WiFIRE® DIGITAL CONTROLLER Your Traeger® Grill is equipped with a state-of-the-art Traeger Controller with WiFIRE® Technology that is Wi-Fi-capable. Before you begin using the grill, familiarize yourself with the different features of the control panel. Once the main power button (located on the back of the pellet hopper) is **ON (I)**, use the **Standby button** to turn on and off the grill.

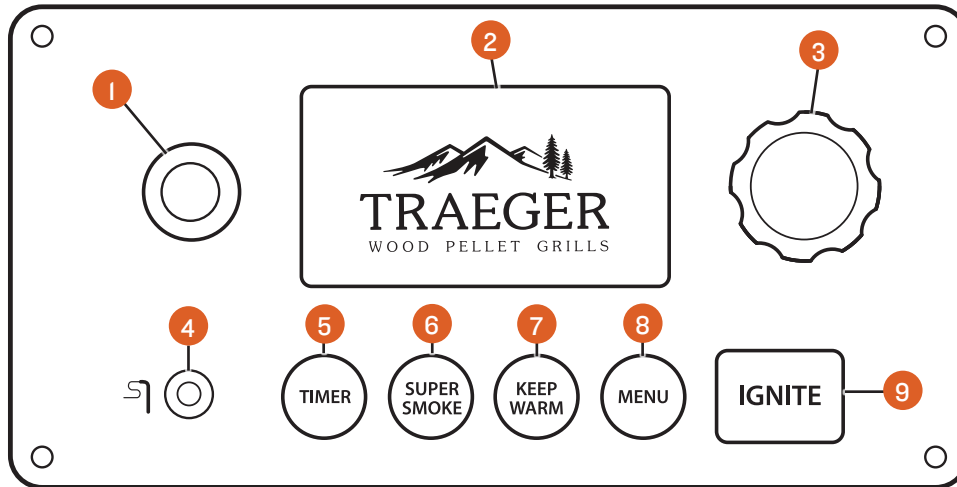

NOTE: Temperature fluctuations are normal for Traeger® Grills. Any significant fluctuation could be the result of wind, air temperature, improper use, or lack of grill maintenance.

1 STANDBY BUTTON

Use this button to turn on and off (standby mode) the electronic controller once the grill's main power switch (located on the back of the grill) has been turned **ON (I)**. Press and hold for 3 seconds to initiate the shut-down cycle when you are finished using your grill. Always run your grill through the full 15-minute shut-down cycle when you are finished using your grill.

2 STATUS DISPLAY

Shows current temperature, status of cook program, cook time remaining, etc.

3 SELECTION DIAL

Rotate dial to move up and down through the displayed menu. Press the center of the dial to make a selection.

4 MEAT PROBE JACK

Plug the meat probe into the jack for probe cooking.

5 TIMER

The timer is for your convenience only; it does not affect grill operation. For example, if you need to baste your meat in 15 minutes, set the timer for 15 minutes. A tone will sound when the time is up.

6 SUPER SMOKE

Select **SUPER SMOKE** at any time during grilling when cook temperature is between 165°–225°F (74°–107°C) to increase the amount of smoke released for additional smoky flavor.

7 KEEP WARM

This feature maintains the grill temperature at 165°F (74°C) to keep food warm.

8 MENU

From **MENU**, you can set up the meat probe and connect your grill to your Wi-Fi network using the Traeger app.

9 IGNITE

Press **IGNITE** to start the grill.

CONNECTING YOUR GRILL

Follow these instructions to connect your grill to Wi-Fi. To learn more about WiFIRE®, the Traeger App, and more ways to connect, go to traeger.com/app.

NOTES:

- Make sure your smart device is running the latest operating system. Always update your Traeger app before each cook.
 - To connect your grill to Wi-Fi, your grill must be powered on. Make sure the main power switch is in the ON (I) position and the grill controller display is on the home screen.
 - Ensure that the Traeger app and your grill are regularly connected to Wi-Fi so that they receive important technical and security updates.
1. Download the Traeger app at the Google Play store for Android or the App Store for Apple.
 2. Ensure your phone or other smart device is connected to the Wi-Fi network to which you want your grill connected.
 3. Open the Traeger app and follow the instructions.

TIPS:

- For best connectivity results, have your grill near your Wi-Fi router and ensure you have a strong Wi-Fi signal.
- A Wi-Fi extender can help improve your Wi-Fi strength.

SEASONING YOUR GRILL

TO BE USED ON INITIAL FIRING ONLY. In order to ensure proper and safe operation of the grill, follow the instructions below, first, to prime the auger (“charge” the auger tube with pellets) and, second, to season your grill (run your grill at a high temperature).

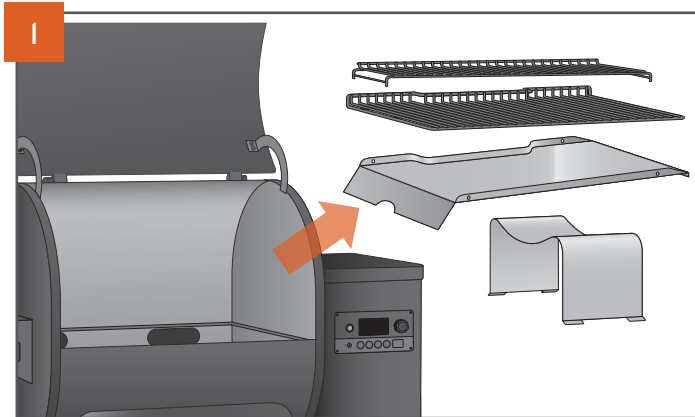

1 Remove the grill grates, grease drip tray, and heat baffle from the inside of the grill.

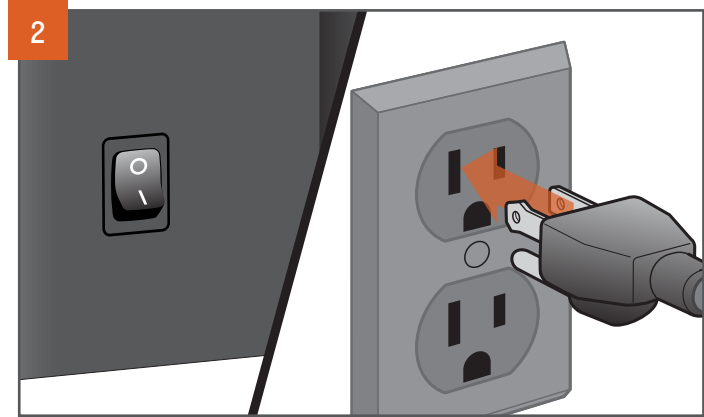

PLUG APPEARANCE MAY VARY BY REGION.

With the main power switch on the back of the grill hopper in the OFF (O) position, plug the power cord into an appropriate grounded/earthed GFCI electrical outlet.

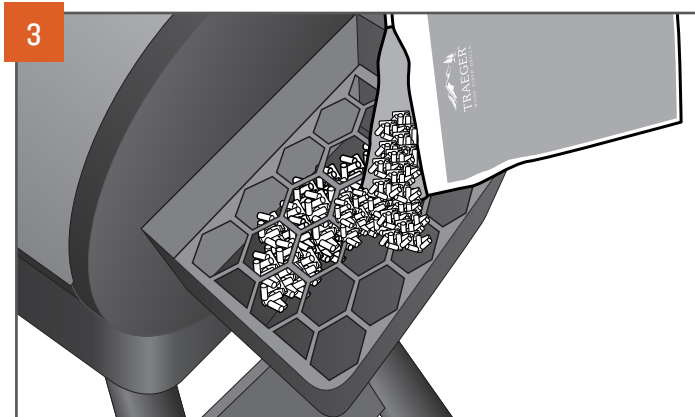

3 Open the hopper lid. Make sure there are no foreign objects in the auger before adding pellets to the hopper. After adding pellets to the hopper, close the hopper lid. We recommend you fill the hopper with pellets at least to the safety grate in the hopper.

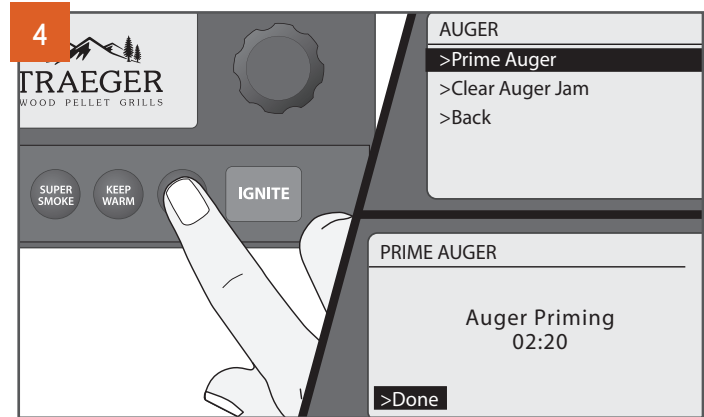

4 Turn grill on: Flip the main power switch on the back of the grill to ON (I); then press the Standby button to wake the grill. Press MENU to display the main menu. Turn the dial to select AUGER, then select Prime Auger.

The auger tube will take a few minutes to fill with pellets and begin dispensing into the firepot. Your grill display will tell you the specific time. To confirm that pellets have reached the firepot, simply check to see that they are moving from the auger tube into the firepot. You only need a few pellets in the firepot to properly ignite your grill and begin the seasoning process. Select Done.

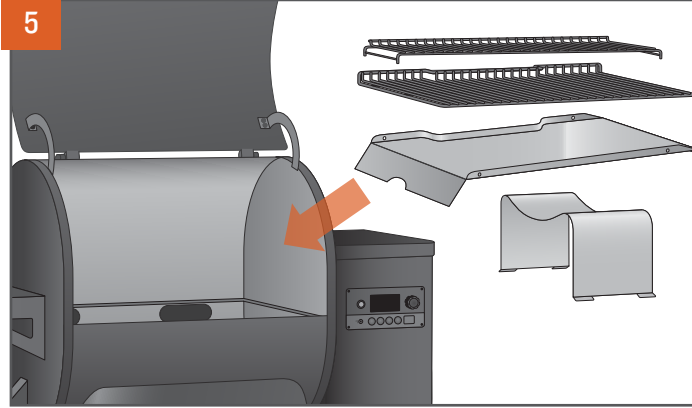

Replace the grill grates, drip tray, and heat baffle after confirming pellets have reached the firepot.

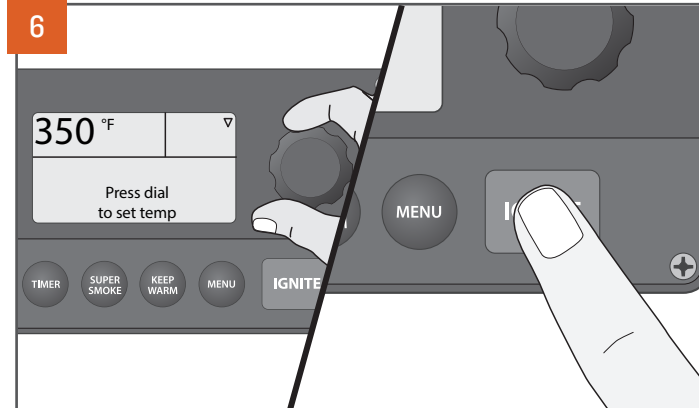

The home screen will display “Press dial to set temp.” Turn the selection dial clockwise to 350°F (175°C) and press the dial. Next, close grill door, press IGNITE, and run grill for 20 minutes once it has reached 350°F (175°C)

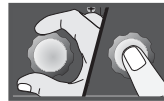

NOTE: To select or confirm a menu option, turn the selection dial to the desired option and press the center of the dial to lock in your selection.

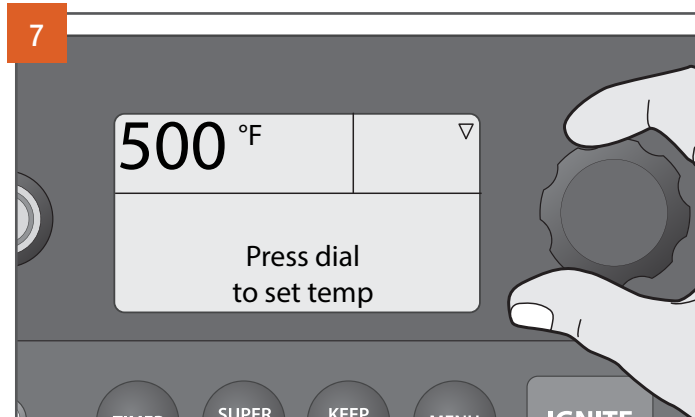

Adjust temperature to 500°F (260°C) and run grill for an additional 30 minutes after it reaches 500°F (260°C).

NOTE: If the auger jams during use, the grill can unjam itself. First, the grill must cool completely for safety. Then press MENU to display the main menu. Turn the dial to select AUGER, then select Clear Auger Jam. The auger will run backwards for 60 seconds to clear any jammed pellets. You do not need to remove the pellets in the pellet hopper.

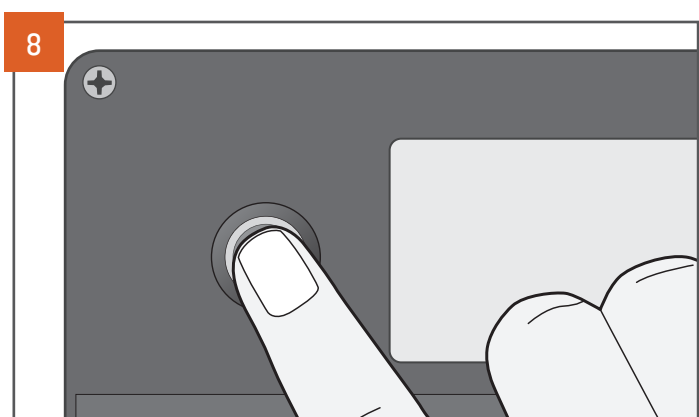

Turn off the grill by pressing and holding the Standby button for 3 seconds, initiating the shut-down cycle. When the full shut-down cycle finishes, seasoning of your grill is complete.

NOTE: The shut-down cycle will run for approximately 15 minutes. Allow the shut-down cycle to complete for proper operation of your grill.



USING YOUR GRILL

YOU WILL NEED TO BEGIN WITH THESE STEPS EVERY TIME YOU USE YOUR GRILL.

PRE-GRILLING CHECKLIST

1. Check for and do needed maintenance:
 - Clean the Traeger® Grease Management System:
 - Grill Grates
 - Drip Tray
 - Grease Trough
 - Grease Chute
 - Grease Bucket
 - Remove ash (after approximately 20 hours of cooking).
 - Check the power cord for twists, damage, or fraying.
2. Make sure the grill is correctly assembled with all parts present before using it:
 - Heat Baffle
 - Drip Tray
 - Grill Grates
3. Make sure you have proper airflow:
 - Ensure nothing is obstructing the exhaust.
4. Make sure the grill is a safe distance from combustibles (see page 2).
5. Make sure the grill is on a level surface.
6. Inspect the pellets:
 - Make sure you have enough pellets in the hopper.
 - Make sure the pellets are not wet, water damaged, swollen, or dull. They should be shiny and easy to snap.
 - Make sure the bottom of the hopper and the auger do not have excessive sawdust.
7. Close the hopper lid.
8. Close the grill door.

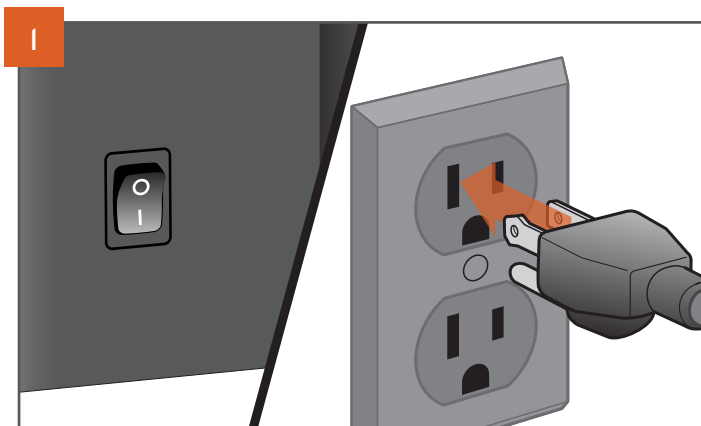

PLUG APPEARANCE MAY VARY BY REGION.

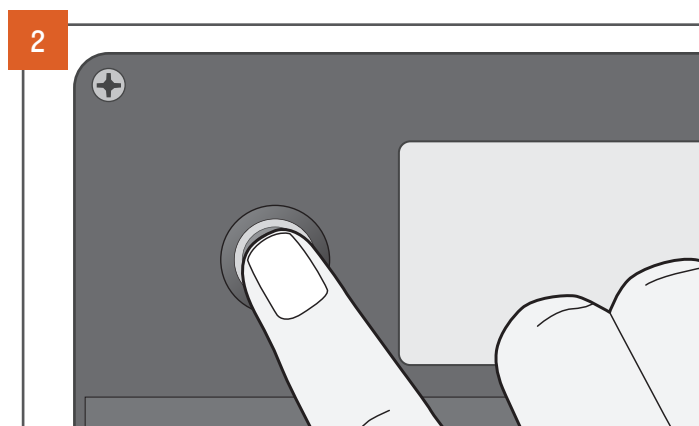

Press the Standby button to wake the grill.



WARNING!

- WHEN OPERATING THIS GRILL, MAINTAIN A MINIMUM CLEARANCE OF 18 INCHES (45.7 CM) FROM GRILL TO COMBUSTIBLES, SUCH AS WOODEN RAILINGS OR HOME SIDING.
- NEVER OPERATE THIS GRILL UNDER A COMBUSTIBLE CEILING OR OVERHANG.
- ONLY OPERATE GRILL OUTDOORS.
- USE ONLY TRAEGER® BRAND HARDWOOD PELLETS, WHICH ARE SPECIFICALLY MADE TO WORK IN OUR GRILLS. NEVER USE HEATING FUEL PELLETS IN THE GRILL.

NOTES:

- The Traeger app for your mobile device makes operating your WiFIRE® Electronic Controller even easier. To connect your phone to your grill, download the Traeger app and follow the instructions. To learn more about Traeger's WiFIRE® app, go to traeger.com/app. Always update the Traeger app to the latest operating version before each cook.
- Whatever cook method you choose, your Traeger® Grill will always begin with an ignition and preheat cycle once you press IGNITE.
- After creating a Custom Cook program, those cycles will run automatically; you will not have to program them.
- Always run your grill through the full shut-down cycle when you are finished using your grill. To initiate the shut-down cycle, press and hold the Standby button.



WARNING! WE RECOMMEND YOU CLEAN THE GREASE DRIP TRAY AND TGMS FREQUENTLY TO REDUCE THE POSSIBILITY OF A GREASE FIRE. PLEASE SEE "MAINTAINING YOUR GRILL" ON PAGE 30 FOR MORE DETAILS.

CHOOSING A COOK METHOD

COOKING AT A SINGLE TEMPERATURE Use this method for simple recipes requiring a single cook cycle at a set temperature.

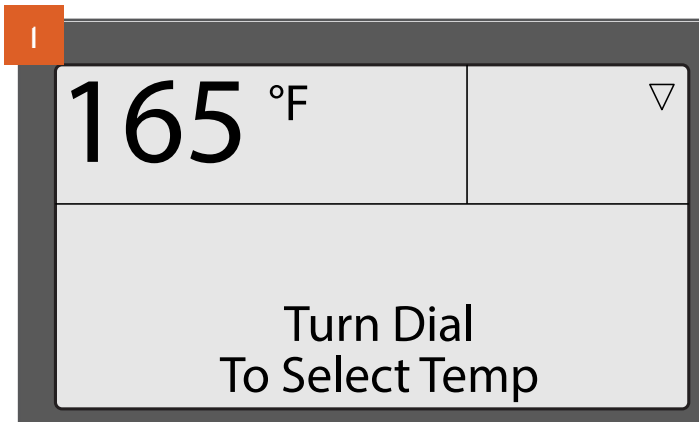

Your grill's home screen defaults to the "Turn Dial To Select Temp" message. Cooking temperature can be set directly from this screen.

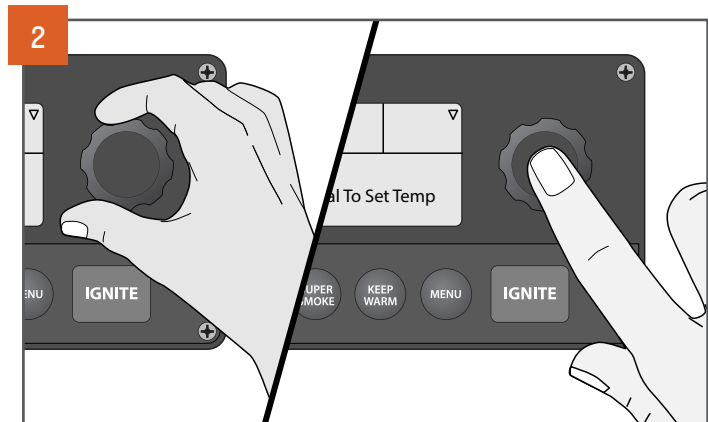

To select temperature, turn selection dial right or left; once desired temperature is displayed, press the center of the dial to select. Close the grill door.

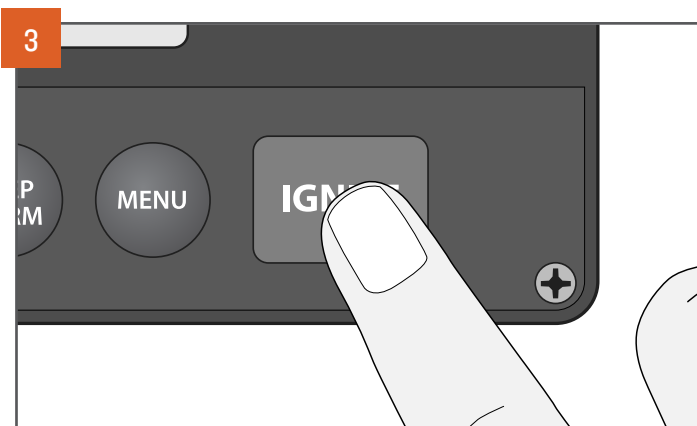

Press IGNITE to begin the automatic ignition and preheat cycle.

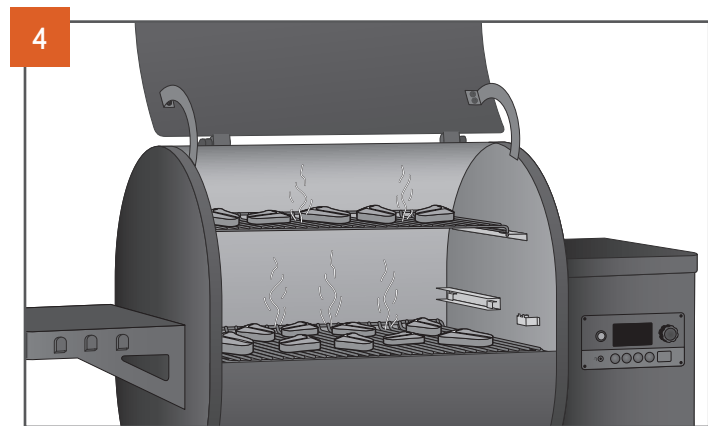

Once preheating is complete, load food into the grill. See page 24 if using the meat probe prior to loading food into the grill.

TIPS:

- It is recommended, but not necessary, to wait until the preheat cycle is complete before loading food into the grill.
- Loading food too early can result in the grill taking longer than usual to achieve desired temperature.
- Keep the grill closed during the preheat cycle so that the grill can reach the desired set temperature.
- Traeger® Grills provide real time temperature readings and you should expect to see fluctuations in temperature.

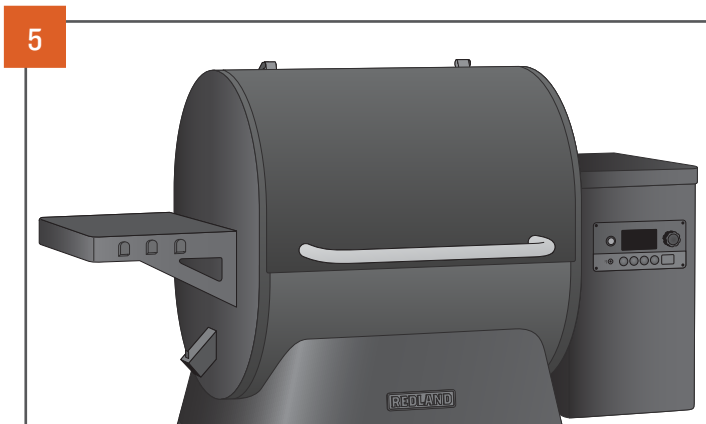

Close the grill door to proceed with cooking. Unlike a gas grill, you must keep the grill door shut during cooking.

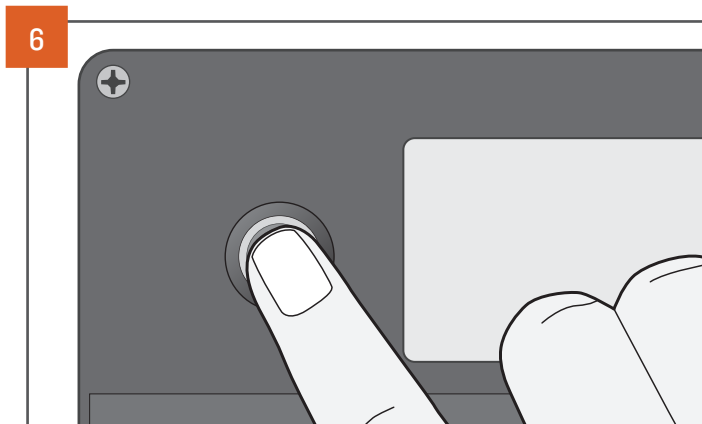

Turn off the grill by pressing and holding the Standby button for 3 seconds, initiating the shut-down cycle.

NOTE: The shut-down cycle will run for approximately 15 minutes. Allow the shut-down cycle to complete for proper operation of your grill.

IN CASE OF FIRE:

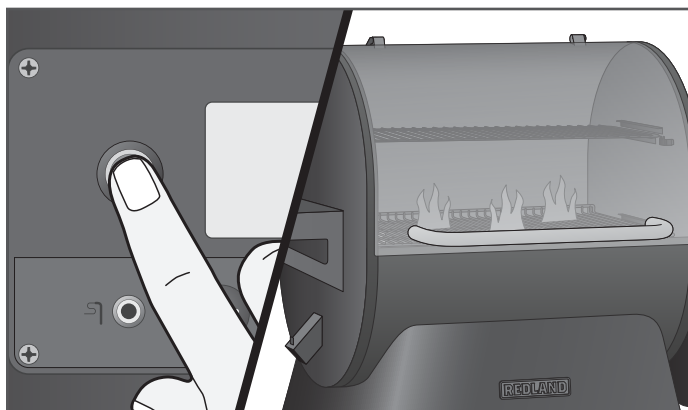

WARNING! WITH REGULAR MAINTENANCE AND CLEANING OF YOUR TRAEGER® GRILL, A GREASE FIRE IS UNLIKELY. IN THE UNLIKELY EVENT OF FIRE, IMMEDIATELY TURN THE GRILL OFF (O) BY PRESSING THE STANDBY BUTTON FOR 3 SECONDS. LEAVE THE GRILL DOOR CLOSED UNTIL THE FIRE IS OUT. UNPLUG THE POWER CORD IF YOU CAN DO SO SAFELY. DO NOT THROW WATER ON THE UNIT. DO NOT TRY TO SMOTHER THE FIRE. WITH THE GRILL DOOR CLOSED, THE FIRE WILL BE STARVED OF OXYGEN AND BURN ITSELF OUT. IF AN UNCONTROLLED FIRE DOES OCCUR, CALL THE FIRE DEPARTMENT.

CHOOSING A COOK METHOD CONTINUED

USING A PRESET CUSTOM COOK CYCLE Your Traeger® Grill comes pre-programmed with two of our most popular custom cook cycles: Beginner's Brisket and Chicken Challenge.

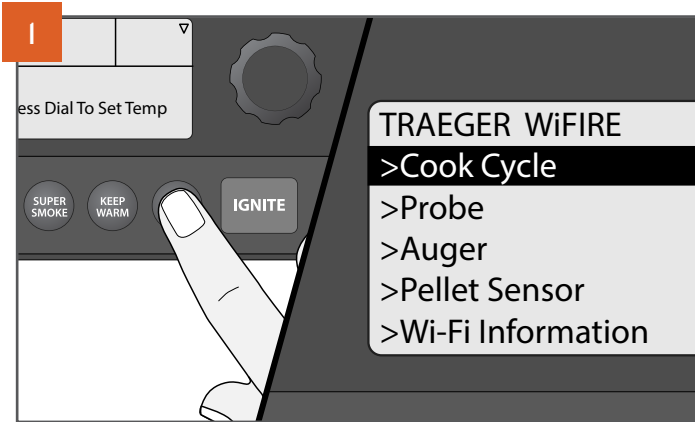

Find the home screen and press MENU. The MENU will now display several options. Select Cook Cycle.



From the Cook Cycle screen, use the selection dial to choose the recipe you want. Press the center of the dial to select.

NOTE: Use your Traeger app to find thousands of recipes to download directly to your grill. You must sync your grill to your home's Internet before you can begin.

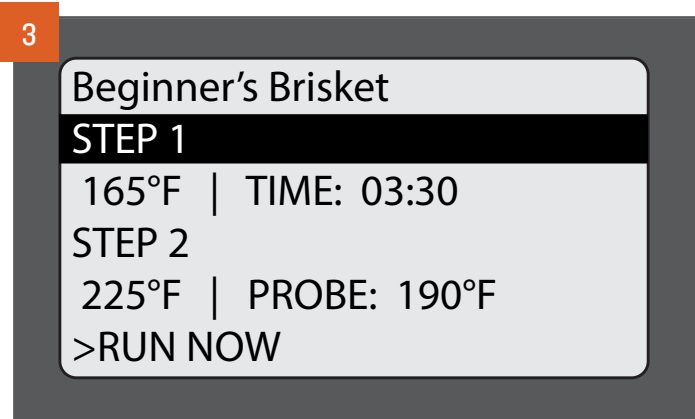

Once a custom cook cycle is selected, the included steps will display. Then, select one of four options: RUN NOW, EDIT, DELETE, or BACK to return to the previous menu.

TIP: If you're in the middle of programming a cook cycle and change your mind, press MENU repeatedly until you return to the main menu, and start over.

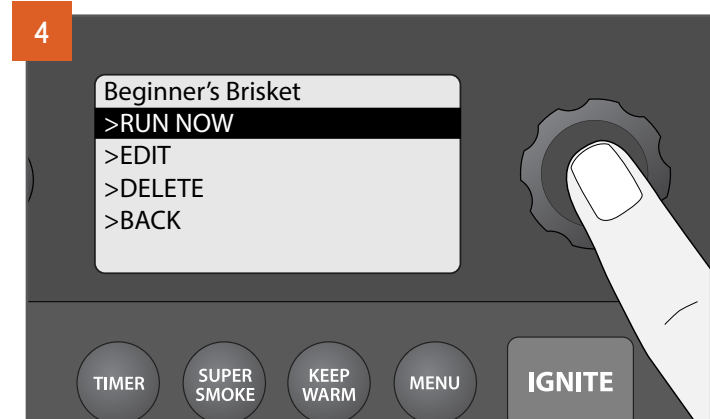

If you want to run the custom cook cycle exactly as-is, select RUN NOW.

NOTE: To edit or add steps, follow the instructions in "Creating a Custom Cook Cycle" on page 22.

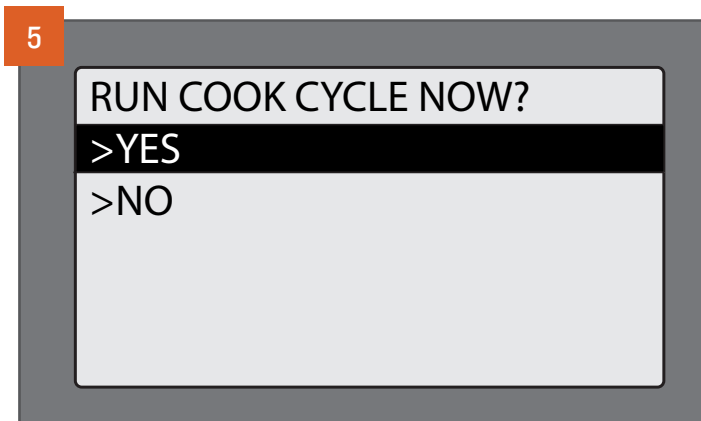

Confirm you want to **RUN COOK CYCLE NOW**, by selecting **YES** at the prompt or **NO** to return to the previous screen.

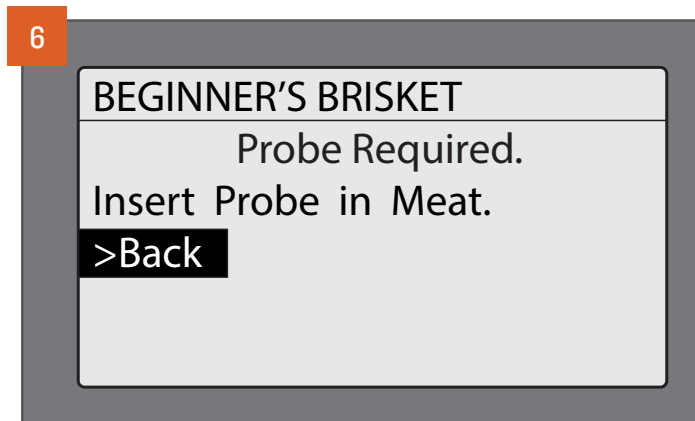

If the probe is required, you'll be instructed to insert the probe into your meat (see "Cooking with the Meat Probe" section on page 24). After you have followed the probe insertion instructions, a tone will sound once to indicate that the probe is recognized. To **RUN COOK CYCLE NOW**, select **YES** at the prompt.

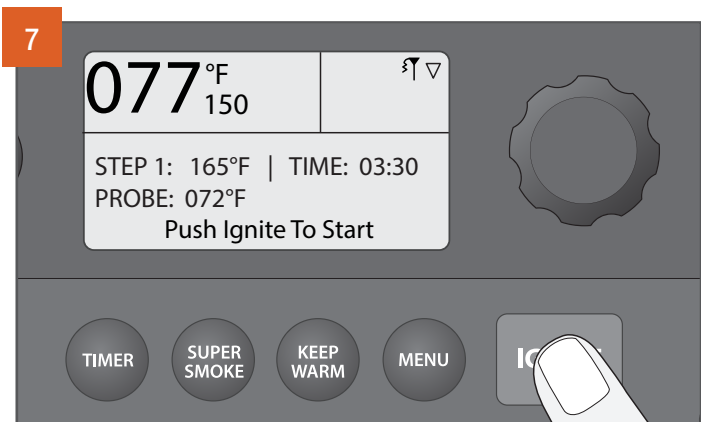

The display will now show the first step of your cook program. Press **IGNITE** to start.

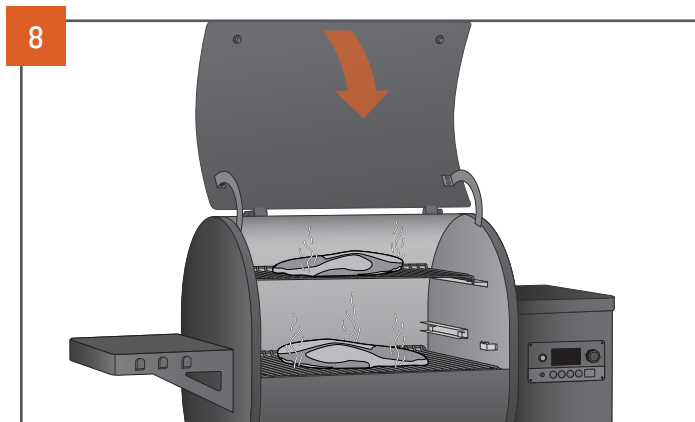

The automatic ignition and preheat cycle will begin. Once preheating is complete, load food into the grill. See page 24 if using the meat probe prior to loading food into the grill. Close the grill door to proceed with your custom cook cycle. Unlike a gas grill, you must keep the grill door shut during cooking.

NOTES:

- If the probe is not plugged in properly, the grill will beep three times. Check to make sure the probe is plugged in properly.
- It is recommended, but not necessary, to wait until preheat cycle is complete before loading food into the grill.

 **WARNING! BURN HAZARD.** MANY PARTS OF THE GRILL BECOME VERY HOT DURING OPERATION. DURING OPERATION OF THE GRILL AND AFTERWARDS, CARE MUST BE TAKEN TO AVOID BURNS WHILE THE GRILL IS HOT.

- THE GRILL DOOR MUST BE CLOSED ONCE THE PREHEAT CYCLE BEGINS.

CHOOSING A COOK METHOD CONTINUED

CREATING A CUSTOM COOK CYCLE Use this method to create and save up to four of your own cook cycles, or to delete or edit an existing cook cycle.



At the Cook Cycle menu, select NEW to display the Steps menu.

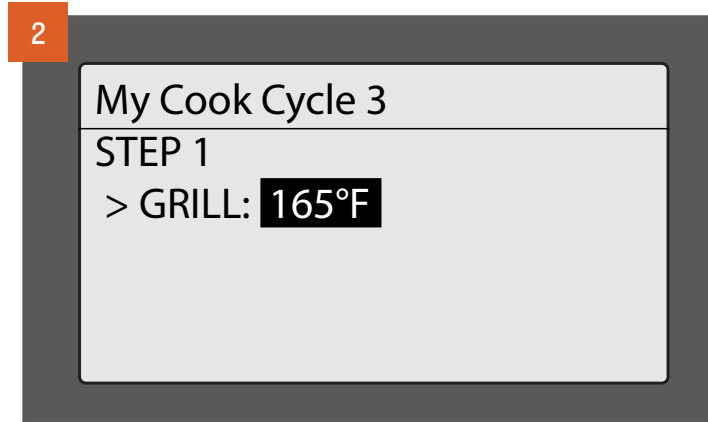

At Step 1, a prompt will display to select a grill temperature (default temperature is 165°F [74°C]). Turn the Selection dial to the desired temperature and press the center of the dial to select.

NOTE: Custom cook cycles allow a maximum of four steps.

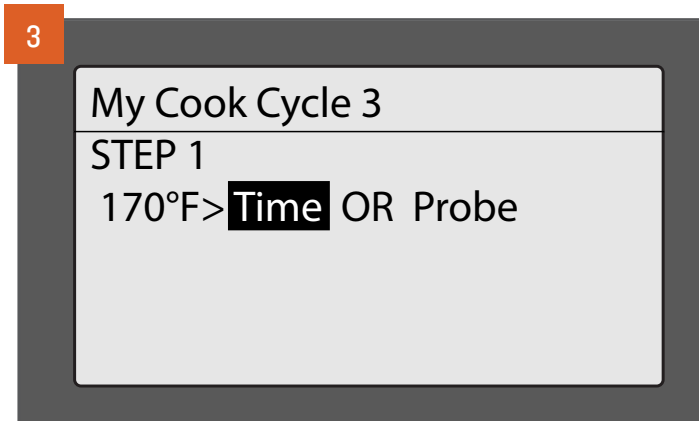

Once temperature is selected, choose either Time to cook for a set time or Probe to cook until the meat probe temperature goal is reached.

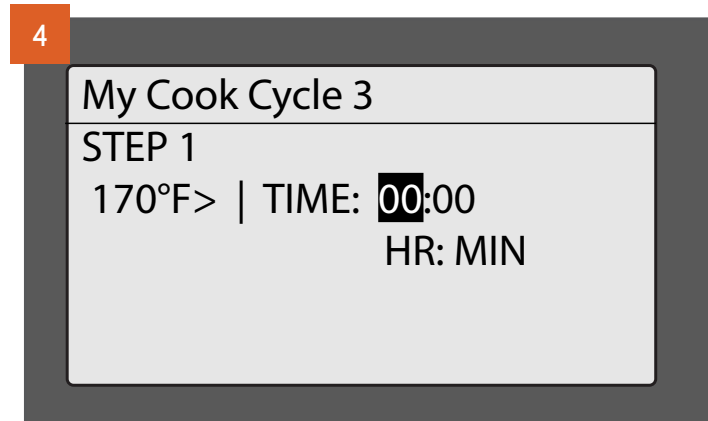

If the recipe calls for a specific number of hours at a set temperature, select TIME. To select hours, rotate the dial. Press to select and move to minutes. Rotate to choose minutes and press the dial to select.

REMINDER: When using the selection dial to choose options, remember to press and hold the center of the dial to select your preferred option.



5

My Cook Cycle 3
 STEP 1
 170°F > Time OR **Probe**

If the recipe calls for cooking the meat to a specific internal temperature, choose Probe. Use the selection dial to select a goal temperature.

6

My Cook Cycle 3
 STEP 1
 170°F | PROBE: 145°F
 >Super Smoke: **OFF**

The option for adding Super Smoke to the step will display. To add Super Smoke, first put on your superhero cape; use the selection dial to toggle from OFF (default) to ON and press the dial center to select. Otherwise, press the dial center to accept the default setting of "OFF."

NOTE: Super Smoke can only be selected with grill temperatures between 165°–225°F (74°–107°C).

7

My Cook Cycle 3
 >STEP 1
 170°F | PROBE: 145°F
 >ADD STEP
 >SAVE
 >DELETE

At this point you'll be returned to the Steps menu for your custom cook cycle. The step you just created will be saved automatically. You can add another step, save the cook cycle as-is, delete the program, or return to the Cook Cycle menu.

8

My Cook Cycle 3
 >ADD STEP
 >SAVE
 >DELETE
 >BACK

Once all steps are added, select SAVE. You will then be asked if you want to RUN COOK CYCLE NOW. If you select YES, you'll be taken back to the home screen and instructed to press IGNITE to start. If you select IGNITE, make sure the grill door is closed. If you select NO, you'll return to the Cook Cycle menu.

REMINDER: There are a total of four memory slots for custom cook cycles on your grill. If you have four custom cook cycles already saved and wish to create a new one, you will need to delete one of them to make room for the new one.

CHOOSING A COOK METHOD CONTINUED

COOKING WITH THE MEAT PROBE Use these methods when your recipe specifies a goal temperature for your food.

IF THE GRILL IS TURNED OFF:

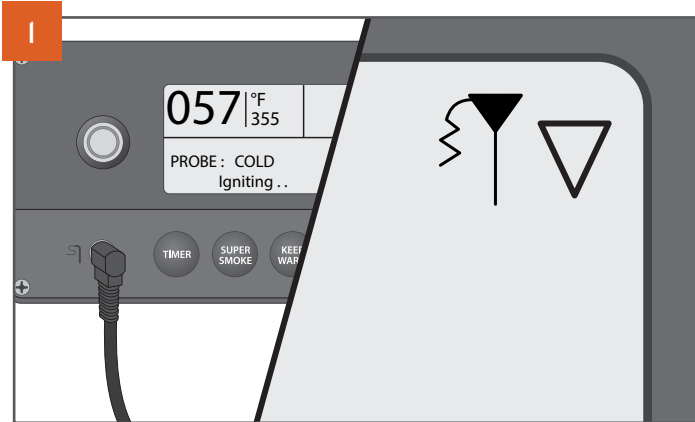

Plug the probe into the probe jack located on the WiFIRE® Controller. See “Using Your Grill” to turn on the grill. Once the grill is on, the controller will recognize the probe and the probe icon will light in the controller screen’s upper-right corner.

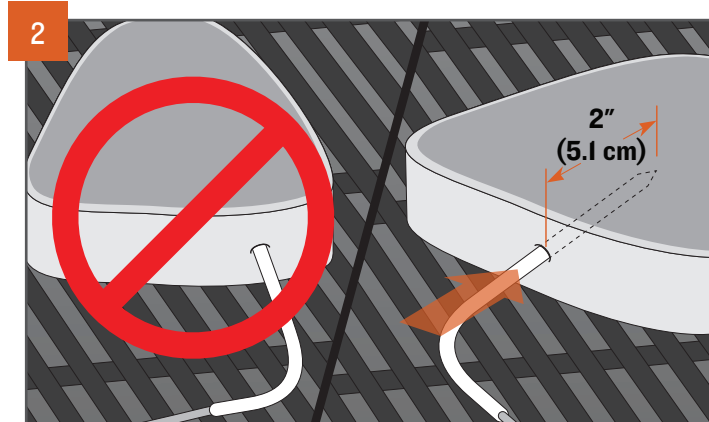

Insert the probe tip into the thickest part of the meat—not in the fatty portion or touching bone. The probe needs to be in the meat at least 2" (5.1 cm). This probe may not be suitable if you can't insert the probe into the thickest part of the meat and 2" (5.1 cm) into the meat.

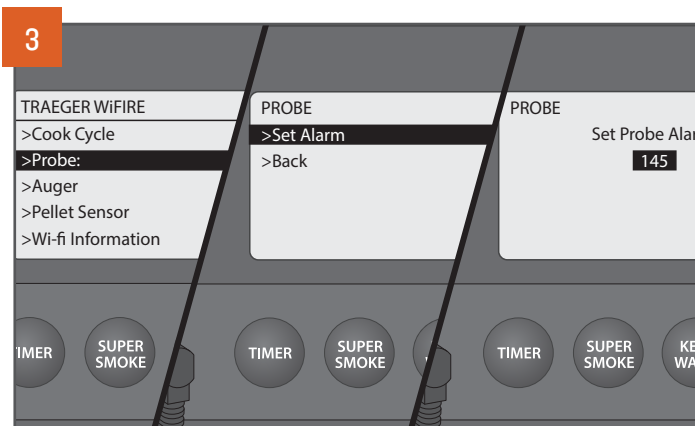

Press MENU; then scroll and select PROBE. You will be prompted to set a probe alarm for the internal goal temperature. Select SET ALARM. Then, at the probe menu, use the selection dial to choose the temperature goal for your meat.

NOTE: To calibrate the probe, see “Additional Control Functions” on page 26.

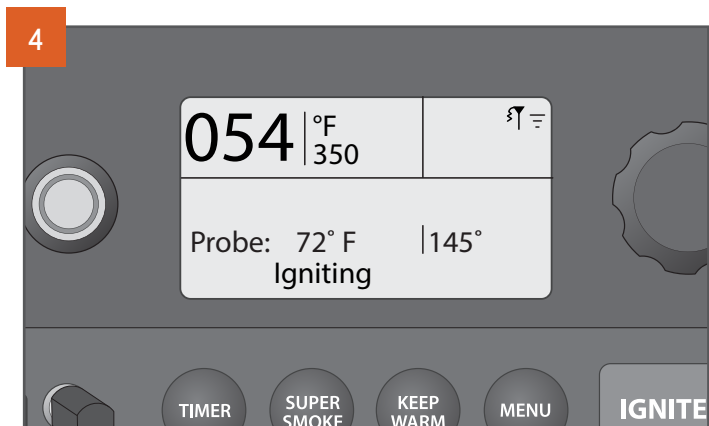

Once the probe alarm is set, the home screen will display the grill temperature, goal probe temperature, and grill status. A tone will sound when your meat reaches the set alarm temperature. If using the Traeger® WiFIRE® app, you will receive a push notification on your connected smart device, along with a display of your grill's status throughout the cooking process. After removing your cook from the grill, always use a meat thermometer to confirm that you have actually achieved the target internal meat temperature.

IF THE GRILL IS TURNED ON:

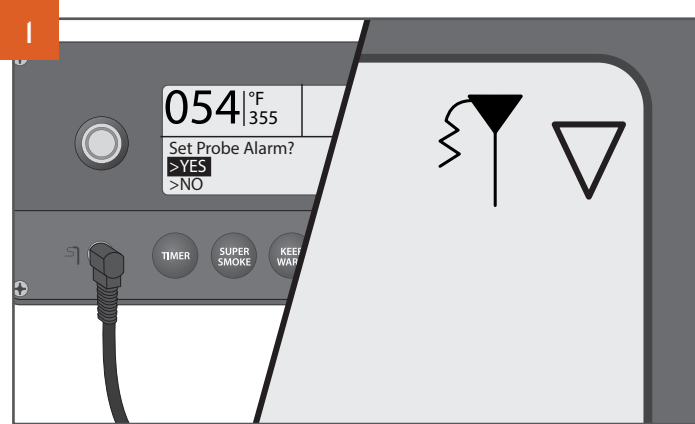

Plug the probe into the probe jack located on the WiFIRE® Controller. The controller will recognize the probe and the probe icon will light in the controller screen's upper-right corner. The display will ask if you want to set an alarm. Select YES.

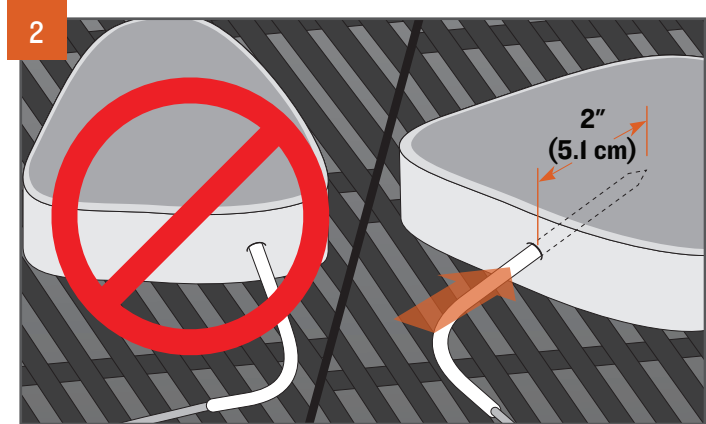

Insert the probe tip into the thickest part of the meat—not in the fatty portion or touching bone. The probe needs to be in the meat at least 2" (5.1 cm). This probe may not be suitable if you can't insert the probe into the thickest part of the meat and 2" (5.1 cm) into the meat.



Rotate the dial to the desired food temperature. Press the dial center to select/confirm.

NOTE: To calibrate the probe, see "Additional Control Functions" on page 26.



Once the probe alarm is set, the home screen will display the grill temperature, goal probe temperature, and grill status. A tone will sound when your meat reaches the set alarm temperature. If using the Traeger app, you can monitor the probe temperature, you can adjust the probe temperature, and you will receive a push notification on your connected smart device when the desired temperature is reached.



WARNING!

- MEAT PROBE IS EXTREMELY HOT DURING AND AFTER COOKING; USE CAUTION WHEN REMOVING.
- IMPROPER PLACEMENT OF THE MEAT PROBE OR IMPROPER MEAT PROBE CALIBRATION COULD RESULT IN RAW OR UNDERCOOKED MEATS, POULTRY, SEAFOOD, SHELLFISH, OR EGGS, WHICH MAY INCREASE YOUR RISK OF FOODBORNE ILLNESS.

ADDITIONAL CONTROL FUNCTIONS

SETTINGS Use the Settings menu to adjust display settings, clear notifications, access important product and contact information, and more.

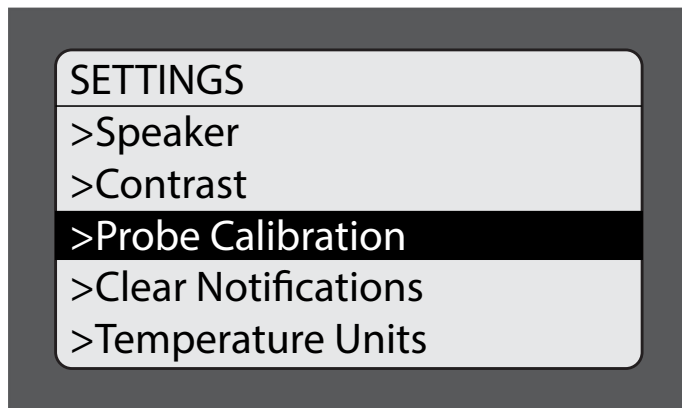
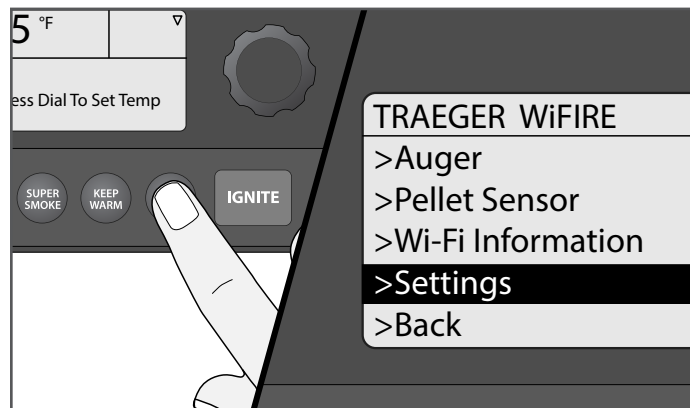

TO ACCESS THE SETTINGS MENU:

Turn grill on. Once the home screen is displayed, press MENU. The main menu will display several options. Turn the dial to highlight “Settings”. Press the center of the dial to select.

To change a setting, turn the dial to select the desired setting. Press the center of the dial to confirm. Select Back to return to the Settings menu.

SPEAKER

Turns the grill control speaker on or off. The selected setting will be indicated with a *.

CONTRAST

Rotate the dial to adjust the display contrast from 1 (high) to 5 (low). Default setting is 3. Press the center of the dial to confirm and return to the Settings menu.

PROBE CALIBRATION

There are two options under this setting:

1. **Calibrate Probe:** Provides instructions on calibrating using an ice water bath. “Place probe in ice water for 1 minute before calibrating.” is displayed.
2. **Probe Offset:** Rotate the dial to adjust the probe temperature offset in 1° increments, from -15°F to +15°F/-8°C to +8°C. The default setting is 0. Press the center of the dial to confirm and return to the Settings menu.

CLEAR NOTIFICATIONS

Use this function to clear error messages and notifications.

NOTE: Since an error will put the grill into Cool Down mode, the display will still show “Cooling Down” when you exit the Clear Notifications and Settings menus.

TEMPERATURE UNITS

Turn the dial to choose between degrees Fahrenheit (°F) and Celsius (°C). Press the center of the dial to confirm. The selected setting will be indicated with a *.

CUSTOMER SERVICE

Displays the Traeger® WiFIRE® dedicated customer service number.

LEARN MORE

Displays link information for the Traeger app and website.

ABOUT GRILL

Provides important information about your grill, including model number and software version.

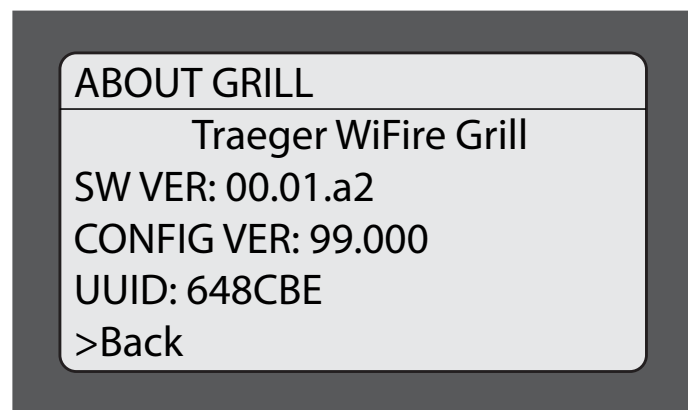

BACK

Return to the main menu.

HOPPER CLEAN-OUT

Your Traeger® Grill has a hopper clean-out system that allows you to remove pellets from the pellet hopper or quickly change from one pellet flavor to another without making a mess.

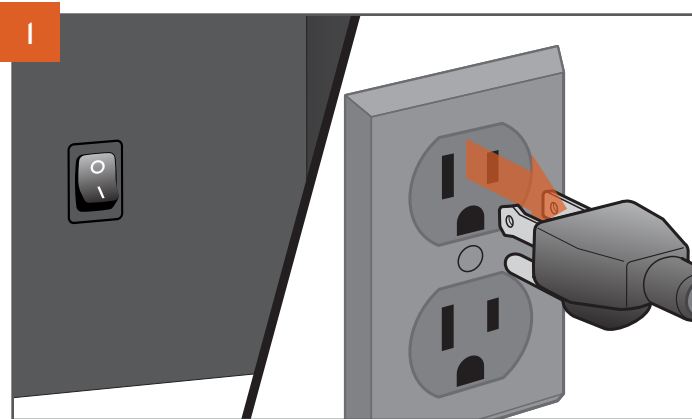

PLUG APPEARANCE MAY VARY BY REGION.

Turn the switch to OFF (0) and disconnect the power cord. If the grill is still hot, allow it to cool completely.



Place a container large enough to hold the unused pellets under the pellet clean-out door.

TIP: A clean 5-gallon (19-liter) bucket works great!



Unscrew the clean-out door fastener and open it. Pellets will empty into the container you've placed below. You might need a spatula or spoon to push the remaining pellets out of the hopper.

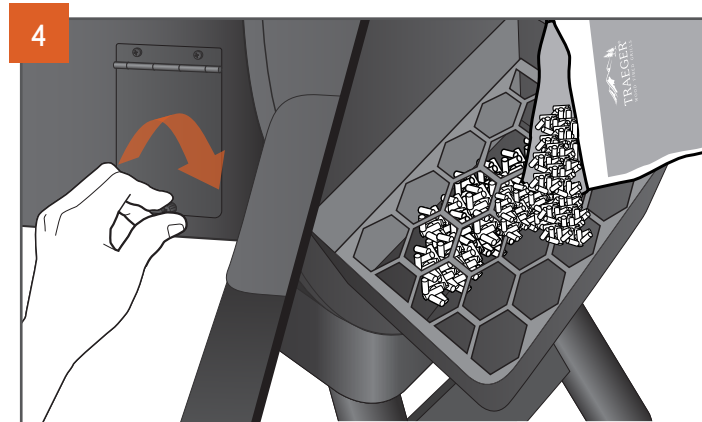

Once the hopper is empty, close the clean-out door, replace the fastener, and refill the hopper with a different flavor of TRAEGER® ALL-NATURAL HARDWOOD PELLETS.



WARNING! DO NOT EMPTY OUT THE HOPPER UNTIL GRILL HAS COMPLETELY COOLED AND THE POWER IS OFF; OTHERWISE, PELLETS MAY BE VERY HOT.

GRILL FEATURES

TRAEGER APP

Your Traeger® Grill can be controlled remotely using the Traeger app. To learn more about WiFIRE®, the Traeger app, and more ways to connect, go to traeger.com/app.

You will need a home internet Wi-Fi connection to connect your Traeger® Grill to the internet. Your smartphone or tablet must be running the latest iOS or Android operating system. If you leave the range of your Wi-Fi networks with your device, a data plan is required. The grill must remain connected to the internet to receive the latest operating, safety, and security updates.

The Traeger app is also an easy way to search, download, and cook new recipes on your Traeger® Grill.



TIMER

Your Traeger® Grill comes equipped with a convenient timer. The Timer function does not impact grill operation; you can use it to notify you of other needed steps during cooking, such as loading vegetables or other shorter time cooks into the grill or basting your food.

TO SET THE TIMER:

1. Press and hold **TIMER** for 3 seconds.
2. Use the selection dial to toggle between hours and minutes to set the time.

Once the dial is pressed after choosing the time, the Timer is set, you will be returned to the homescreen, and the Timer will automatically begin the countdown.

TO CANCEL THE TIMER:

1. Press and hold **TIMER** for 3 seconds.
2. You will see the options to Edit, Cancel, or go Back to the menu.

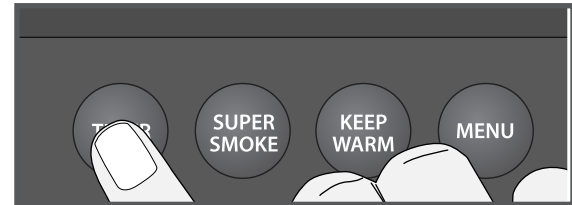

SUPER SMOKE FEATURE

You can add more smoke flavor to your food by pressing **SUPER SMOKE**. Press it again to cancel.

NOTE: Super Smoke can only be activated when grill temperature is between 165°–225°F (74°–107°C).



KEEP WARM FUNCTION

Keep Warm can be used to pause the cook cycle at any time during grilling and maintain the grill temperature at 165°F (74°C). Press the **KEEP WARM** button to activate the function. Press **KEEP WARM** again to resume cooking.





TRAEGER PELLET SENSOR (included only with Redland XL; available for Redland as an accessory)

The Traeger Pellet Sensor monitors the supply of pellets. Once selected from the menu, it will display the current level of pellets as a percentage in increments of 5%. If the Traeger Pellet Sensor is properly connected it will display “PELLET SENSOR Pellet Level: XX%.” If the Traeger Pellet Sensor is not properly connected it will display “PELLET SENSOR Sensor Disconnected Pellet Level: 0%.”

The Traeger Pellet Sensor allows you to check the status of your pellet level remotely using the Traeger app. This system will send you push notifications and alarms through the Traeger app on your smart device when your pellets are getting low, protecting your cook from running out of fuel.

VERSATILE LOWER GRATE

You can change the placement of the bottom grill grate for two different cooking options: Sear Position and Smoke Position.

In Sear Position, the grill grate should be placed at the lowest point in the grill body cavity, resting on the lowest back brackets and the lip at the front. This ensures that the radiant heat from the grease drip tray is maximized and your food has sear marks.

For Smoke Position, place the grill grate on the higher front brackets, sliding it into the channel at the back. This will allow the smoke to fully circulate for convection cooking.

NOTE: The upper grate has two positions, center and back. There are storage hooks on the rear of the skirt for the upper grate while not in use.

RACK STOPS

Located at the front of the slider brackets for the bottom grate, rack stops provide additional stability when accessing food. Simply slide the grate out until the crossbar catches in the rack stop, and you'll be able to flip burgers or baste ribs easily without the rack tipping.

GRILL COVER

Protect your Traeger® Grill with a Traeger® brand custom-fit cover, designed to protect your grill from the elements. This durable grill cover is available at your local dealer or for purchase at traeger.com.



WARNING! FIRE HAZARD: DO NOT INSTALL YOUR GRILL COVER UNTIL THE GRILL HAS COMPLETELY COOLED.

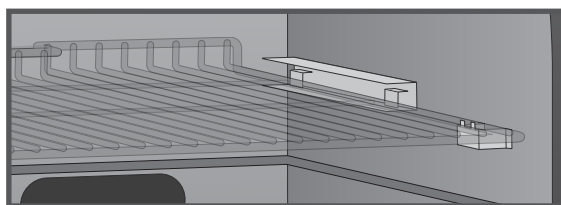
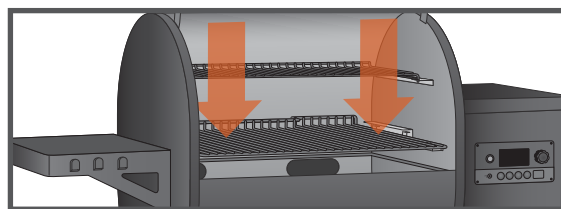
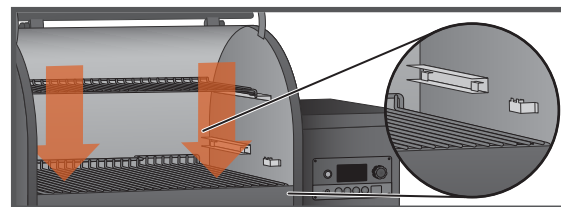
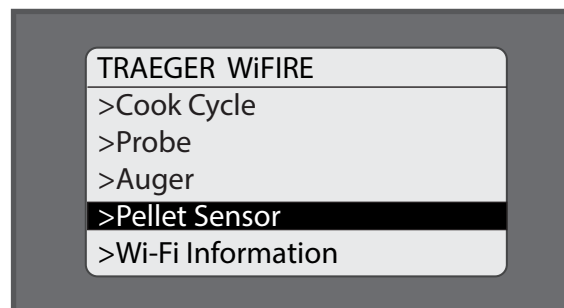

MAINTAINING YOUR GRILL

⚠ WARNING **Fire Hazard:** Grease fires are most frequently caused by failing to properly maintain the grill by not cleaning the grease from the grill on a consistent basis.

⚠ WARNING Turn the main power switch on back of the grill hopper OFF (O) and disconnect the power cord before initiating any of the maintenance below.

1. CLEANING YOUR TRAEGER® GREASE MANAGEMENT SYSTEM (“TGMS”):

During your cooks, grease drippings will fall onto (i) the grease drip tray and be channeled into (ii) the grease drain (the “Trough”) and then out of the grill through (iii) the grease drain tube, (iv) to be collected in the grease bucket. These four components are the components of the Traeger® Grease Management System (TGMS). Grease will accumulate in all of these locations and should be regularly cleaned to reduce the risk of fire.

How often you need to clean the TGMS depends on the fat content of your food. Fattier foods will require cleaning of the TGMS more often, and sometimes you will need to clean the TGMS after every cook.

Visible pieces of food and bits of hardened grease or other buildup indicate a need for cleaning.

All components of the TGMS should be inspected before each use for signs of grease buildup.

⚠ WARNING Accumulated grease is easier to clean off when the grill is still warm—not hot. **Be careful not to burn yourself. Heat-protective gloves are recommended.**

Clean the grease out of the V-shaped grease drain (the “Trough”) and grease drain tube. We recommend cleaning these locations regularly.

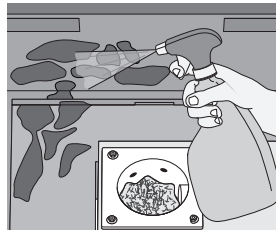

Remove all grill grates and the grease drip tray. This will provide access to the V-shaped grease drain and grease drain tube opening inside the grill.

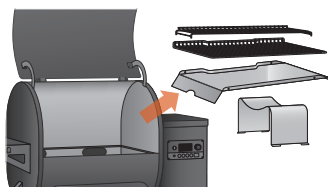

Scrape the grease accumulation from inside the V-shaped grease drain and grease drain tube using a stiff, nonmetallic tool. Much of the loosened grease can be pushed down through the grease drain tube and will fall into the grease bucket. Wipe up remaining grease residue with paper towels or disposable rags.

Regularly clean the grease out of the grill barrel on the interior bottom and sides. If grease is allowed to build up, a grease fire could result.



Scrape the grease accumulation from inside the grill using a stiff, nonmetallic tool. Much of the loosened grease can be removed using paper towels or disposable rags. Excessive scraped-off residue can be cleaned using a vacuum cleaner as described in Step 4 (below) when cleaning the firepot of ashes.

Inspect and clean the heat baffle for any grease or debris.

NOTE: Traeger's drip tray liners can help keep your grill clean and can help reduce the risk of flare-ups.

2. CREOSOTE REMOVAL:

When wood pellets are burned slowly, they produce tar and other organic vapors that combine with expelled moisture to form creosote. The creosote vapors condense in the relatively cool exhaust vent of a slow-burning fire. As a result, creosote accumulates on the exhaust vent lining. When ignited, creosote makes an extremely hot fire. Airborne grease particles will travel through the cooking chamber, and some of this airborne grease will accumulate on the exhaust vent lining, similar to creosote, which could contribute to a fire.

Periodically scrape the creosote and grease accumulation from the inside of the vertical and horizontal sections of the flue pipe or interior lining using a stiff, nonmetallic tool. A wooden paint stir stick, for example, would work for this task. Once the creosote and grease residue has been loosened from the interior lining and ventilation gaps in this downdraft system, much of it can be removed with paper towels or disposable rags. Do not spray water or other liquid cleaners onto the inside of your grill to remove creosote.

NOTE: The Traeger® Downdraft Exhaust System should be inspected at least twice a year to determine when a creosote and/or grease buildup has occurred.

When creosote or grease has accumulated, it should be removed to reduce the risk of a fire.

3. OUTSIDE STORAGE:

⚠ CAUTION If the grill is stored outside, care should be taken to ensure that water does not get into the pellet hopper. Wood pellets expand greatly when wet and will jam your auger. Always cover your grill when not in use with a Traeger® Grill Cover. This custom-fit cover can be purchased at traeger.com.



4. CLEANING THE ASH FROM INSIDE AND AROUND THE FIREPOT (AFTER APPROXIMATELY 20 HOURS OF COOKING):

⚠ WARNING Make sure that the grill is **COLD** and ashes are extinguished and **COLD** before cleaning the ash.

⚠ WARNING Disposal of ashes should be done only according to the following instructions.

Excess ash in the firepot will hamper ignition and may cause your fire to go out. The firepot should be inspected occasionally and cleaned to remove the ash buildup. Again, cleaning the ash from in and around the firepot should be done only when the grill is **COLD**.

Remove the grill grates, grease drip tray, and heat baffle to provide access to the firepot and the interior of the grill. Much of the ash outside of the firepot can be removed from the grill with a small metal fireplace shovel or other similar tool.

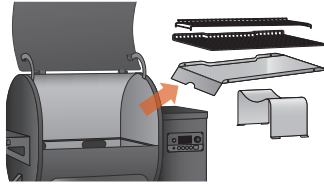

⚠ WARNING A dedicated vacuum cleaner is the best way to remove ashes from the firepot, but this must be done with extreme care to avoid the risk of fire. Again, cleaning the ash from in and around the firepot should be done only when the grill is **COLD**.

A utility-type vacuum cleaner having a metal collection canister without a bag would be best for this task. However, almost any vacuum cleaner will work safely if this procedure is properly followed.

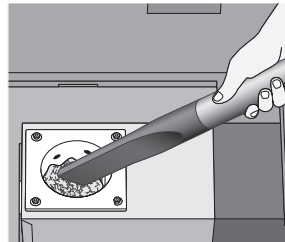

After ensuring that the ash in the firepot is **COLD**, vacuum the ash from the inside of the firepot.

- a. If your vacuum cleaner is a bagless model, empty any previously accumulated debris from the collection chamber. Then vacuum the ash from the inside of the firepot. Once the firepot is clean, empty the collection chamber into the metal container handled in the manner described below under Disposal of Ashes without delay. Make sure that there is no remaining ash residue left in the collection chamber.
- b. If your vacuum cleaner is a model that uses a disposable bag, install an unused bag in the machine. Then vacuum the ash from the inside of the firepot. Once the firepot is clean, remove the bag from the vacuum cleaner and place it in a metal container handled in the manner described under Disposal of Ashes below.

5. DISPOSAL OF ASHES:

⚠ WARNING Ashes should always be completely cool before handling. Ashes should be placed in a metal container with a tight-fitting lid. The closed container of ashes should be placed on a noncombustible floor or on the ground, well away from all combustible materials, pending final disposal. Ashes should be retained in the closed container until they are disposed.

6. CLEANING THE GRILL GRATES:

⚠ WARNING Cleaning the grill grates works best while they are still warm. **Be careful not to burn yourself. Heat-protective gloves are recommended.** We recommend keeping a long-handled cleaning brush near the grill. After removing your food, give the grill grate a quick brushing. It takes only a minute and it will be ready the next time you want to use the grill.

7. CLEANING OUTSIDE SURFACES:

⚠ WARNING Turn the main power switch **OFF (O)** and disconnect the power cord before initiating cleaning.

Use a disposable rag or cloth dampened with Traeger® All Natural Cleaner or warm, soapy water to wipe the grease from the outside of the grill. **DO NOT** use oven cleaner, abrasive cleansers, or abrasive cleaning pads on the outside grill surfaces.

8. TESTING THE GRILL AFTER CLEANING:

Before replacing the heat baffle, grease drip tray, and the grill grates, plug the power cord into an appropriate grounded/earthed electrical outlet and turn the switch **ON (I)**. After you set the temperature and press **IGNITE**, pellets should fall into the firepot and the hot rod should begin to heat (it will start to turn red).

⚠ WARNING Do not touch the hot rod.

When flames start to come out of the firepot, run the shut-down cycle. Let the grill cool down. Now you're ready to place the heat baffle, grease drip tray, grill grates, and food back onto the grill.

9. POWER CORD

If the power supply cord is damaged, it must be replaced by a special cord assembly available from Traeger.

FREQUENTLY ASKED QUESTIONS

Scan this QR code to take you to Frequently Asked Questions.



TROUBLESHOOTING

ERROR MESSAGES

This is a connected product. To ensure you are receiving the latest firmware updates to keep your grill operating at its peak performance, always make sure your grill is connected. See “Connecting Your Grill” on page 13.

Although rare, you may see an error or warning message display on your control panel. Please refer to the following chart for a list of error messages and how to resolve them:

ERROR MESSAGE	SOLUTION
<p>LOW TEMP ERROR (LEr)</p>	<p>This error will occur if the temperature of the grill falls below 120°F (49°C) for 10 minutes, causing the grill to go into shut-down mode. Shut-down mode will continue for an additional 10 minutes. To correct this, you must allow the grill to cool to a safe temperature. Unplug the grill. Completely remove all pellets and ash from the firepot and any pellets that may have fallen inside the grill. When restarting the grill after a Low Temp Error, turn off the controller; then turn it back on. If the problem persists, contact customer service (see page 36). Ensure that you have properly maintained your grill as described in “Maintaining Your Grill” on pages 30–31. The most common causes of a low temp error are improper startup procedure, lack of maintenance, or running out of pellets during a cook.</p> <p>⚠ WARNING Fire Hazard. Do not restart grill without completely removing ALL pellets from the firepot. Do not attempt multiple restarts without following these care and cleaning instructions each time. Failure to follow these instructions could cause pellets to overflow into the base of the grill, creating a fire hazard.</p>
<p>HIGH TEMP ERROR (HEr)</p>	<p>This error will occur when the temperature in the grill reaches temperatures above 550°F (288°C) for more than 45 seconds, causing the grill to shut off the fan and auger motor. Let the grill cool completely, then turn off the grill. Inspect the hopper, auger, and firepot. Ensure that you have properly maintained your grill as described in “Maintaining Your Grill” on pages 30–31. Clear out any remaining pellets from the firepot and grill body and restart your grill. If the problem persists, stop using the grill and contact customer service (see page 36). The most common cause of a high temp error is improper startup procedure after a low temp error.</p>
<p>SLOW IGNITION</p>	<p>This message will occur when there is no significant temperature rise after 15 minutes of ignition. A slow ignition warning does not indicate that it will not ignite; it is simply communicating it is taking a little longer to ignite. Make sure your grill is connected and on the latest firmware.</p>
<p>FAILED TO IGNITE</p>	<p>This error will occur if the grill is out of pellets, pellets are wet, pellets are old, or the igniter did not light. Please scan the QR code on page 31 for “Frequently Asked Questions”. Make sure your grill is connected and on the latest firmware.</p>
<p>IGNITER DISCONNECT</p>	<p>This error will occur when the controller does not detect the igniter. Check to see if the igniter is connected and restart your grill. See traeger.com/support for proper procedure to check if igniter is disconnected. If the issue persists, contact customer service (see page 36).</p>
<p>FAN DISCONNECTED</p>	<p>This error will occur when the controller is no longer getting a reading from the fan. This is caused by the fan connection on the back of the controller becoming disconnected, a bad wire, or a faulty fan. Go to traeger.com/support for steps on how to check the connection. If the issue persists, contact customer service (see page 36).</p>
<p>AUGER DISCONNECTED</p>	<p>This error will occur when the controller is no longer getting a reading from the auger. This is caused by the auger connection on the back of the controller becoming disconnected, a bad wire, or a faulty auger. Go to traeger.com/support for steps on how to check the connection. If the issue persists, contact customer service (see page 36).</p>



ERROR MESSAGE	SOLUTION
AUGER OVERCURRENT	This error will occur if the auger motor is damaged or jammed. Use the Clear Auger feature inside the control menu and restart your grill. If the problem continues, you may need to replace your auger motor. Go to traeger.com/support or contact customer service (see page 36) for further troubleshooting. Make sure your grill is connected and on the latest firmware.
LOW AMBIENT TEMP	This warning will occur when the ambient temperature at the controller falls below -20°F (-29°C) for 30 seconds. This would likely only display if the LCD heater is broken. The error is cleared once the grill warms up above -20°F (-29°C).
INSERT PROBE	This message will occur during a custom cook if the probe is required and disconnected. Insert the probe into the controller to clear the message.
LOW TEMP DETECTED – “LOW TEMP DETECTED”	This message will occur if grill temperature drops below the set temperature for 4 minutes. This is not necessarily a problem; the grill is just communicating a low temperature detection. If the grill cannot recover from this state, you will likely get a low temp error (LEr) (see page 32). Make sure your grill is connected and on the latest firmware.
THERMOCOUPLE DISCONNECTED ERROR – “TEMP SENSOR OUT”	This error will occur when the controller is no longer getting a reading from the thermocouple. This is caused by the thermocouple connection on the back of the controller becoming disconnected, a bad wire, or a faulty thermocouple. Go to traeger.com/support for steps on how to check the connection. Make sure your grill is connected and on the latest firmware. If issues persist, contact customer service (see page 36).
PELLET LEVEL LOW ERROR – “PELLET LEVEL LOW”	This error will occur when pellet sensor detects the pellet level is at or below 25%. Fill with pellets to remove this message.
PELLET LEVEL CRITICAL ERROR – “ADD PELLETS”	This error will occur when pellet sensor detects the pellet level is at 0%. Fill with pellets to remove this message. Not filling with pellets could result in a low temp error (LEr) (see page 32).
LOW TEMP WARNING	This warning will occur if the grill has lost its fire and failed to recover. Check the pellets and restart the grill.
IGNITION WARNING (APP NOTIFICATION ONLY)	This warning will occur if the grill has not detected a successful ignition in the expected time. Check the pellets and restart the grill.
COLD WEATHER STARTUP	This warning will occur when the ambient temperature falls below -20°F (-29°C) for more than 30 seconds. Although the controller will still work, damage to the controller’s display may have occurred. If the grill ignites, check to see if the display operates as expected. If the grill does not ignite, warm the grill and check to see if the display and controller operate as expected. Make sure your grill is connected and on the latest firmware. If not, contact customer service (see page 36).
PROBE FELL OUT	This warning will occur if the probe is not properly inserted into the food. The message is triggered when the probe is above 220°F (104°C) while the grill is running. Reinsert the probe into your food as instructed on pages 24-25.
BAD PROBE	This warning will occur if the controller detects a malfunction in the probe for 10 seconds. The probe will need to be replaced. To order a new probe, go to traeger.com or contact customer service (see page 36).

CLEARING NOTIFICATIONS

After you address the issue listed in the notification, you can clear notifications with the Menu - Settings - Clear Notifications menu item.

TROUBLESHOOTING CONTINUED

WiFIRE® PROBLEMS/QUESTIONS

PROBLEM/QUESTION	RECOMMENDED SOLUTION
App is constantly showing “Lost Connection Attempting to Reconnect.”	<p>Wi-Fi signal could be weak. Try moving the grill closer to the router or the router closer to the grill, or extending your wireless network.</p> <p>The weak signal could be a result of an obstruction between the grill WiFIRE® antenna located within the hopper assembly and your home network. Positioning the hopper side of the grill to face the network signal origin and/or removing obstacles could result in signal improvement.</p>
Grill status in app displays as “Unknown.”	<p>Try turning your grill off and on.</p> <p>Restart app/restart phone.</p> <p>Try re-pairing network in the grill settings:</p> <ol style="list-style-type: none"> 1. Go to the Remote section of the app. 2. Select the gear icon in the upper-right corner on the grill screen. 3. Select “Re-Pair Network” under Grill Settings. <p>Delete grill from the app and disconnect it from your Wi-Fi network:</p> <ol style="list-style-type: none"> 1. Go to the Remote section of the app. 2. Select the gear icon in the upper-right corner on the grill screen. 3. Select “Delete Grill” under Grill Settings. 4. Re-pair the network under Grill Settings.
I want to change/update the name of my grill.	<ol style="list-style-type: none"> 1. Go to the Remote section of the app. 2. Select the gear icon in the upper-right corner on the grill screen. 3. Select “Edit Grill Name” under Grill Settings.
How can I see how strong the Wi-Fi signal is on the grill?	<ol style="list-style-type: none"> 1. Go to the Remote section of the app. 2. Select the gear icon in the upper-right corner on the grill screen. 3. Select “Grill Settings,” then “Network Settings.” 4. Wi-Fi strength will be displayed: <ul style="list-style-type: none"> • Excellent: signal strength is > -50 db • Good: signal strength is -50 to -59 db • Fair: signal strength is -60 to -69 db • Poor: signal strength is -70 to -79 db • Unusable: signal strength is < -80 db
Can I ignite my grill using the app?	No. You must start your grill manually. Remote start is not available through the app.
Can I shut down my grill using the app?	<ol style="list-style-type: none"> 1. Go to the Remote section of the app. 2. Select the gear icon in the upper-right corner on the grill screen. 3. Select “Shut Down Grill.”
It says my grill is already assigned to another account. What should I do?	Contact customer service (see page 36).
How do I delete a grill from my account?	<ol style="list-style-type: none"> 1. Go to the Remote section of the app. 2. Select the gear icon in the upper-right corner on the grill screen. 3. Select “Delete Grill” under Grill Settings. 4. Turn on your grill. 5. Press the Menu button, then scroll to Wi-Fi Settings. 6. In Wi-Fi Settings, select “Forget Network.”

OPERATING TIPS

1. We are always working to improve your grill's performance. Make sure your grill is connected and has the latest firmware update. For instructions on checking your firmware version, go to traeger.com.
2. You can change the temperature at any time during grilling to increase or decrease cooking temperature. It is best practice to give the grill some time to reach the desired temperature before making additional temperature changes.
3. To change between Fahrenheit and Celsius: Select Temperature Units from the Settings menu. Turn the dial to choose between degrees FAHRENHEIT (°F) and CELSIUS (°C). Press the center of the dial to confirm. The selected setting will be indicated with an *. You will now see temperatures displayed in the format you've chosen.
4. Your Traeger® Grill is designed to operate with the door closed. Opening the grill door greatly lengthens your cooking time.
 - When putting frozen, raw, cold, or otherwise uncooked food on the grill, this may result in a temporary drop of your grill's internal temperature.
5. Do not overload cooking surface with excessive amounts of food that reach beyond the edges of the footprint of the drip tray. This can lead to interference with proper cooking airflow and may lengthen the time to reach the set temperature.
6. Always take into account the type of food you are cooking:
 - Thin foods need high heat and shorter cook times, while thicker foods need low heat and longer cook times.
 - Vegetables take longer to cook than meats at the same cooking temperatures.
 - Always check that the internal temperature of the meat that you are cooking reaches a safe temperature for eating.
 - The Keep Warm function is not designed to properly cook your food.
7. Keep the grill clean. Regularly inspect your grill for accumulated grease. Most grease fires are caused by not properly maintaining the grill and failing to clean the Traeger® Grease Management System (TGMS) on a consistent basis (see "Maintaining Your Grill" on pages 30-31). Even if there is ample room in the grill, be cautious of loading excessive amounts of food that can release large quantities of flammable grease (for example more than a pound of bacon). If the grill has not been well maintained or if your previous cooks have produced large quantities of flammable grease, it is highly recommended that the grease be cleaned from the grill before using it again.

NOTE: Take care of your grill by using a new Traeger® drip tray liner before each cook to help keep your grill clean.

SERVICE



TRAERGER'S LEGENDARY CUSTOMER SERVICE is the best out there. If you have any questions about your Traeger® Grill or need tips on cooking your first holiday turkey, our seasoned experts have your back. We're here for you 365 days a year, including holidays. For assistance with assembly, installation, safe operation, parts, or general customer service, you can visit our website traeger.com/support or you can phone or write us at:

TRAERGER'S CUSTOMER SERVICE

Please visit: traeger.com/support
Phone: US/CA: 1-800-TRAERGER 6:00 a.m. – 10:00 p.m. MT
Address: TRAERGER PELLET GRILLS LLC
1215 E. Wilmington Ave., Suite 200
Salt Lake City, UT 84106

TRAERGER'S CUSTOMER SERVICE IS JUST A SCAN AWAY

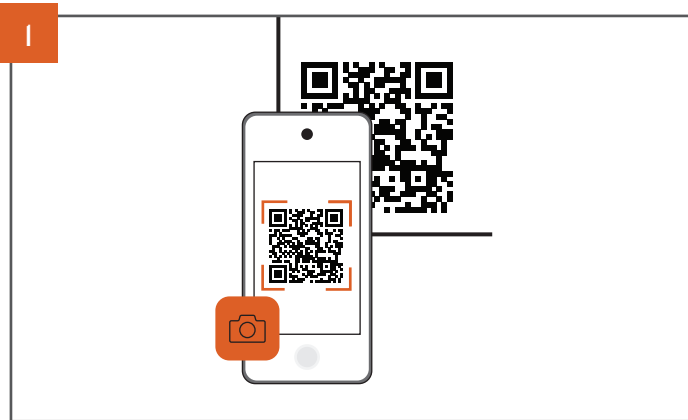

Open the camera on your phone and point it at the QR code.

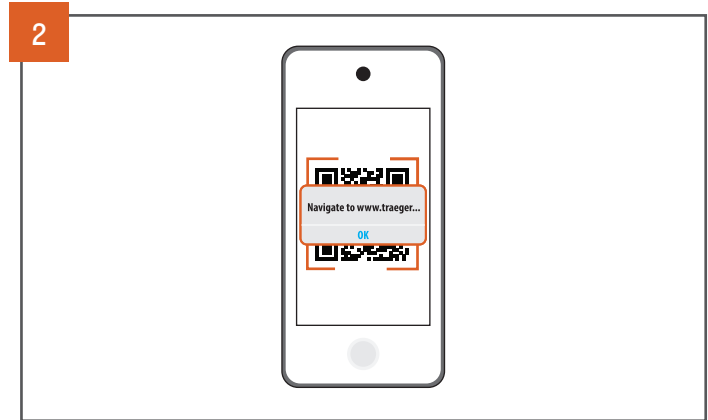

Wait for the camera to register and tap the notification or banner when it appears on your screen.

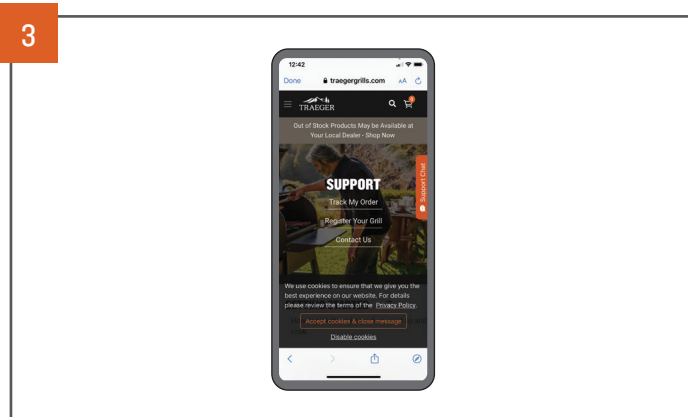

Information related to the code will automatically load.

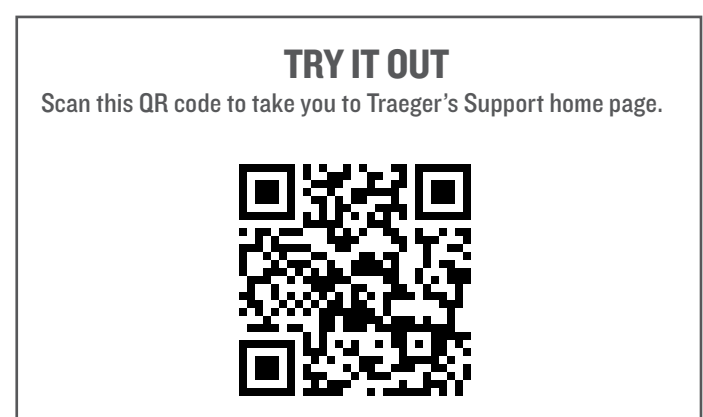



NOTES



TRAEGER® GRILL WARRANTY



7-YEAR LIMITED WARRANTY

Traeger Pellet Grills LLC warrants this Traeger® Grill for the components, coverage, and warranty period listed in the table below under normal use and proper maintenance. This warranty gives you specific legal rights, and you may also have other rights which may vary among states and provinces. The warranty period starts from the date of original purchase from traeger.com or a Traeger authorized dealer. A list of Traeger authorized dealers is available at <https://www.traeger.com/dealers> (together each an "Authorized Seller"). The warranty period and coverage for the replacement parts shall be as follows:

Warranty Periods and Coverage		
Components	Warranty Period	Coverage
Body, Legs, Stainless Steel Shelf, Hopper Cover	7 Years	Will not rust through
Grates	3 Years	Will not rust through
Auger, Auger Motor, Fan, Controller	3 Years	Material and Manufacturing Defects
Casters, All Terrain Wheels	3 Years	Material and Manufacturing Defects
Hot Rod, Pellet Sensor, Cord, RTD, Thermocouple	1 Year	Material and Manufacturing Defects
Heat Baffle, Drip Tray	1 Year	Will not rust through
Door Gasket	1 Year	Will not tear or fray
Meat Probe	1 Year	Material and Manufacturing Defects



Traeger's entire liability and your exclusive remedy shall be replacement of the defective parts of your Traeger® Grill, if any. Original part(s) approved for return by Traeger's Customer Service must be returned prepaid. Traeger may replace defective parts with new or refurbished parts, at Traeger's sole discretion on an as available basis within ninety days. Without limiting the exclusions stated above, there is not warranty coverage for: (i) paint damage caused by grease fires, (ii) UV exposure, (iii) normal wear and tear; and (iv) warping of the drip tray or heat baffle.

Traeger grills are designed to be modular for simple repair by regular users. Traeger's entire obligation under this warranty shall be to provide you with replacement of any defective parts and to provide you with instructions on how to make the replacement yourself. Traeger may replace defective parts with new or refurbished parts. Traeger reserves the right to inspect any grill (shipping paid by Traeger) and to analyze any usage information including, without limitation, any digital connected grill data (to the extent covered by our data protection policy). To validate and process a warranty claim Traeger may require that you provide reasonable evidence of your issue, including participating in video chats, phone conversations, providing photos, and providing other relevant information. Labor charges connected with the replacement of defective parts and freight charges to ship parts shall be paid at your expense.

The limitations in the following paragraph do not apply to residents of Quebec to whom the Quebec Consumer Protection Act applies.

FOR GREATER CERTAINTY AND TO FULLEST EXTENT PERMITTED BY LAW, TRAEGER PELLET GRILLS LLC SHALL NOT BE LIABLE UNDER THIS OR ANY IMPLIED WARRANTY FOR INCIDENTAL, CONSEQUENTIAL DAMAGES, INDIRECT, SPECIAL, LOSS OF DATA, EXEMPLARY, PUNITIVE OR ENHANCED DAMAGES, LOST PROFITS OR REVENUES OR DIMINUTION IN VALUE ARISING OUT OF OR RELATING TO YOUR USE OF YOUR GRILL, REGARDLESS OF (A) WHETHER SUCH DAMAGES WERE FORESEEABLE, (B) WHETHER OR NOT TRAEGER WAS ADVISED OF THE POSSIBILITY OF SUCH DAMAGES AND (C) THE LEGAL OR EQUITABLE THEORY (CONTRACT, TORT, OR OTHERWISE) UPON WHICH THE CLAIM IS BASED, AND NOTWITHSTANDING THE FAILURE OF ANY AGREED OR OTHER REMEDY OF ITS ESSENTIAL PURPOSE. THIS WARRANTY GIVES THE RETAIL CUSTOMER SPECIFIC LEGAL RIGHTS AND THE CUSTOMER MAY HAVE OTHER RIGHTS WHICH VARY FROM STATE/PROVINCE TO STATE/PROVINCE. BOTH YOU AND TRAEGER INTEND FOR THIS WARRANTY TO BE YOUR EXCLUSIVE REMEDY FOR A DEFECTIVE GRILL.

This warranty shall be void if: (i) the grill is not assembled or operated in accordance with Traeger's operating instructions provided with this grill; (ii) the grill is not purchased from an Authorized Seller; (iii) the grill is resold or traded to another owner; (iv) there has been use of any third party components, parts, or accessories; (v) fuels other than wood pellets designed for wood pellet grills and barbeques have been used with the grill; (vi) wood stove heating pellets are used in the grill; (vii) the grill has been used in a commercial or food service application; (viii) the user has allowed the grill to become damaged, abused, or otherwise failed to maintain the grill in accordance with Traeger's operating instructions; or (ix) there has been any unapproved modification of this grill.

Please note that because Traeger is unable to oversee or control the quality of its products sold by unauthorized sellers, Traeger's warranty is only available if you purchased your grill from an Authorized Seller. Traeger's warranty extends only to products purchased from an Authorized Seller.

To process a warranty claim, contact Traeger's customer service at the phone number or address listed above. Traeger requires proof of your date of purchase from an Authorized Seller. You should retain your sales slip or invoice along with this manual with your valuable documents.

Customers outside of the United States and Canada should note that NOT all warranty policies stated herein are consistent globally. Customers should contact the local distributor in their current country from the list at International Support for instructions regarding warranty claims specific to that country. The process described herein will not work for international warranty requests.

ADDITIONAL IMPORTANT WARRANTY INFORMATION

- We are not responsible for items lost in transit. For this reason, we highly recommend getting a tracking number or delivery confirmation when shipping your package.
- The product you send to us becomes the possession of Traeger and will not be returned to you.

Traeger will determine if your warranty claim is covered under this warranty policy at Traeger's sole and complete discretion, and failure to follow the required procedures may void your warranty claim. This warranty gives you specific legal rights, and you may also have other rights which vary from State/Province to State/Province or Country to Country.





WELCOME
TO THE
TRAEEGERHOOD

FOLLOW US @TRAEEGERGRILLS



Traeger Pellet Grills LLC
1215 E. Wilmington Ave., Suite 200
Salt Lake City, UT 84106

traeger.com

Made in China